

MOULDING PATTERNS

SIXTH EDITION

\$10.00

INTRODUCTION

O.B. WILLIAMS COMPANY has provided millwork for many of the Pacific Northwest's finest landmarks since 1889.

As a founding member of the national Architectural Woodwork Institute, O.B. Williams Company has helped create and uphold its industry's most stringent quality standards.

In a world where many have come to expect standardized products, we have continued our tradition of manufacturing custom doors, windows, cabinets, paneling, stairs and mouldings with virtually no limits to their design.

The sophistication of our equipment and our high level of craftsmanship enable O.B. Williams Company to maintain its reputation as the Northwest's quality leader in architectural woodwork.

MOULDINGS are key in defining the style of any architecture. A well-conceived system of mouldings, whether traditional or contemporary, will reflect quality in any project.

O.B. Williams Company mills all mouldings to order, giving customers a full choice of all domestic and exotic woods, cuts, and length structures, with a limitless choice of profiles.

The mouldings shown in this catalog are some of the more popular patterns we run, but in no way limit one's options. We can grind moulder knives to mill any profile desired, whether to match an existing moulding or to create a new one.

Since all mouldings are custom milled, modifications to the profiles are easy to accommodate. For instance, a base moulding shown at 3-3/8" wide actually can be milled to any width. Our sales staff will be glad to discuss options to suit your individual needs.

We appreciate your interest in our work and invite your further inquiry.



INDEX

APRONS	78-87
ASTRAGALS	31
BACK BANDS	50-51
BAR RAILS	61
BASE MOULDINGS	2-9, 92-96
BASE CAPS	62
BRICK / SHAKE MOULDS	29-30
CASING	10-16, 88-96
CHAIR RAILS	35-37
CORNER MOULDS	49
COVE MOULDING	19-20, 40-44
CROWN MOULDING	17-28, 98-100
DRIP CAP	39
EDGE SHAPES	97
GLASS STOPS	47
HANDRAILS	52-60
LINTEL CAPS	45-46
MISCELLANEOUS	67-69
PANEL MOULDING	62-65
PICTURE FRAME	66
PICTURE MOULDS	48
RAILING	52-60
ROSETTES	101
ROUNDS - FULL, HALF & QTR.	38
SCREEN MOULDING	45
SHAKE MOULDING	29-30
SHOES	47
STOPS	47
SYMMETRICAL CASING	14-15, 74-77
TONGUE & GROOVE / SIDING	32-34
WALL CAPS	70-73

BASE MOULDINGS

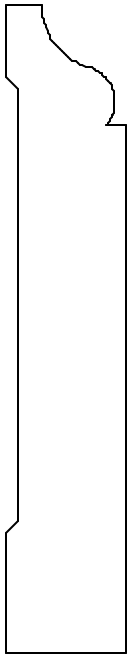

OB1001
5/8 X 3-3/8

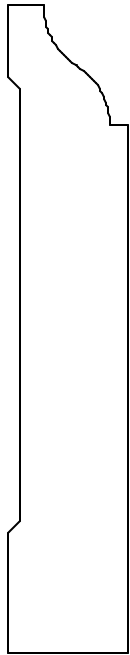

OB1002
5/8 X 3-3/8



OB1003
1/2 X 3-3/8

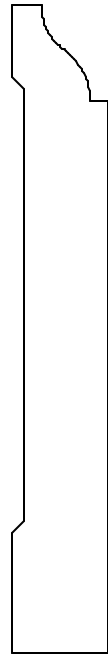

OB1004
1/2 X 3-3/8

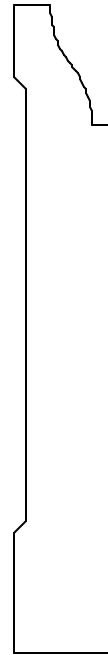

OB1005
1/2 X 3-3/8



OB1006
1/2 X 3-3/8

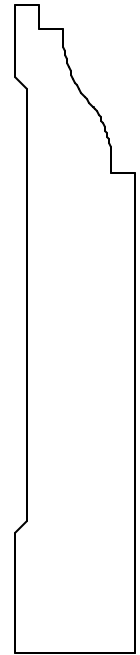

OB1007
5/8 X 3-3/8

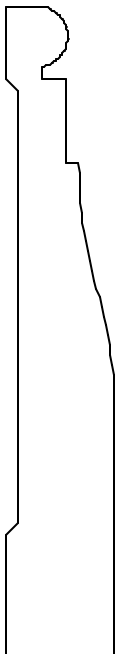

OB1008
9/16 X 3-3/8



OB1009
9/16 X 3-3/8



OB1010
9/16 X 3-3/8

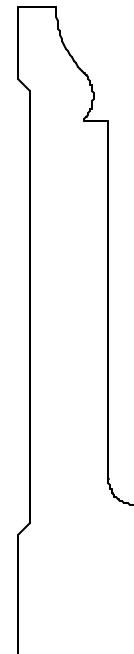

OB1011
5/8 X 3-3/8

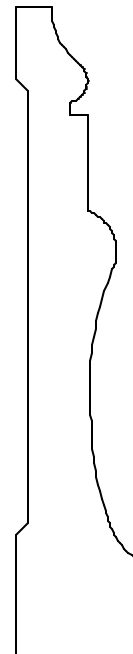

OB1012
5/8 X 3-3/8

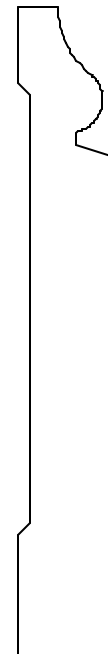

OB1013
1/2 X 3-3/8



OB1014
1/2 X 3-3/8

MOST OF THE ABOVE MOULDINGS CAN BE MADE TALLER AND ALL CAN BE MADE THICKER THAN SHOWN
ALL MOULDINGS ARE MADE TO ORDER AND ARE AVAILABLE IN ANY SPECIES OF WOOD.

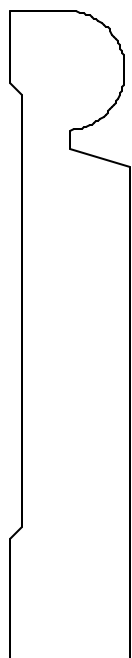

OB1015
5/8 X 3-3/8

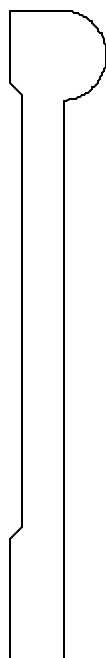

OB1016
1/2 X 3-3/8

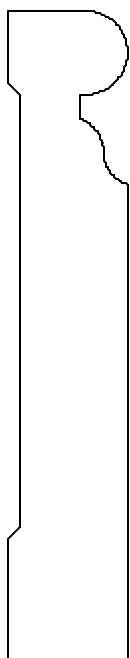

OB1017
5/8 X 3-3/8



OB1018
1/2 X 3-3/8

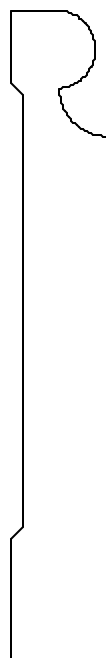

OB1019
1/2 X 3-3/8

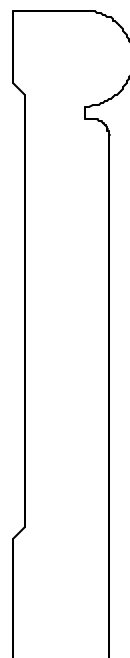

OB1020
5/8 X 3-3/8



OB1021
5/8 X 3-3/8

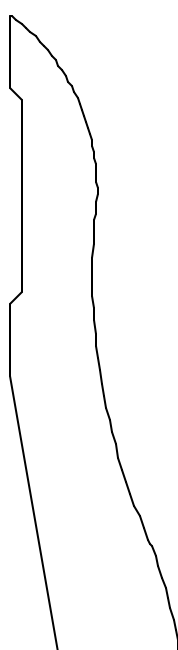

OB1022
7/8 X 3-5/16

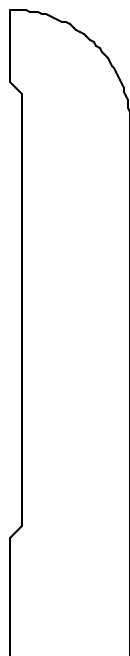

OB1023
5/8 X 3-3/8



OB1024
5/8 X 3-3/8



OB1025
1/2 X 3-3/8

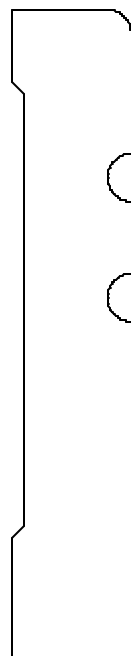

OB1026
5/8 X 3-3/8

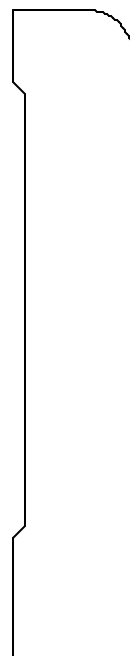

OB1027
5/8 X 3-3/8



OB1028
1/2 X 3-3/8

MOST OF THE ABOVE MOULDINGS CAN BE MADE TALLER AND ALL CAN BE MADE THICKER THAN SHOWN
ALL MOULDINGS ARE MADE TO ORDER AND ARE AVAILABLE IN ANY SPECIES OF WOOD.

O.B. WILLIAMS COMPANY

ESTABLISHED 1889

1939 FIRST AVE. SO. SEATTLE, WASHINGTON 98134 (206) 623-2494 FAX 623-2602

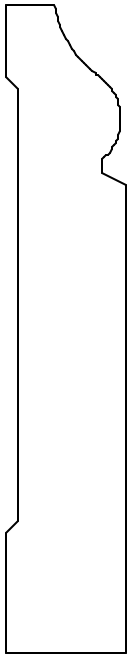

OB1029
5/8 X 3-3/8

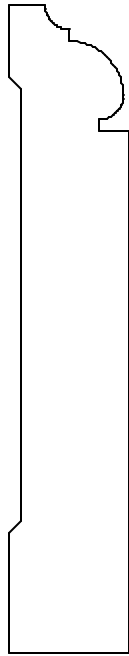

OB1030
5/8 X 3-3/8

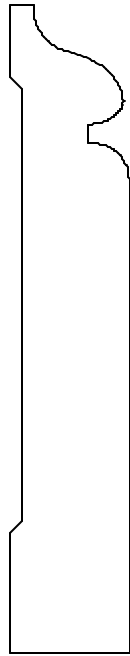

OB1031
5/8 X 3-3/8

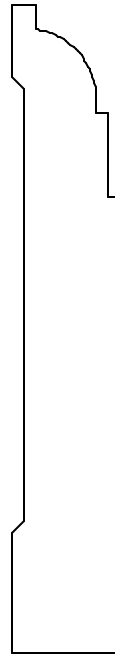

OB1032
9/16 X 3-3/8

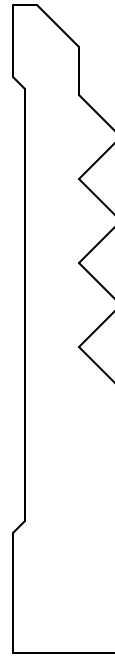

OB1033
9/16 X 3-3/8

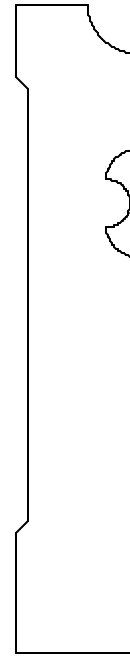

OB1034
5/8 X 3-3/8

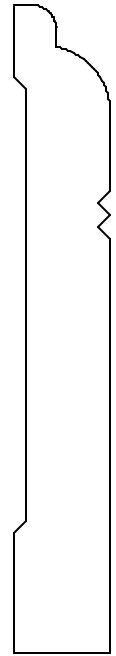

OB1035
1/2 X 3-3/8



OB1036
5/8 X 4-3/8

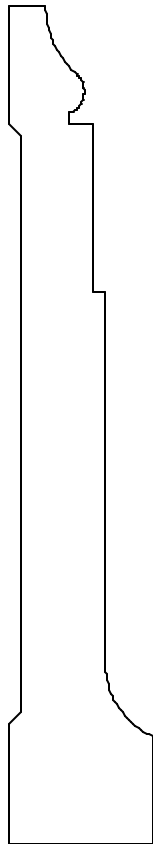

OB1037
3/4 X 4-3/8

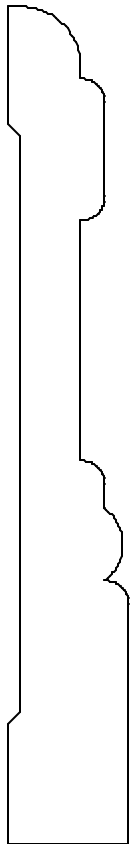

OB1038
5/8 X 4-3/8

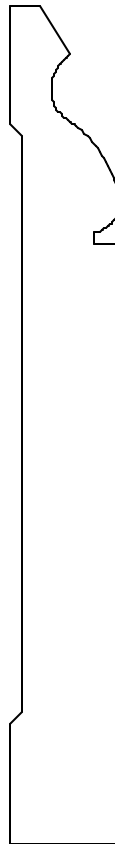

OB1039
5/8 X 4-3/8

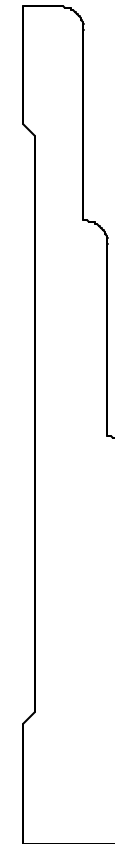

OB1040
9/16 X 4-3/8

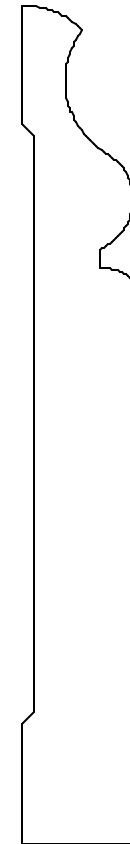

OB1041
5/8 X 4-3/8



OB1042
5/8 X 4-3/8

MOST OF THE ABOVE MOULDINGS CAN BE MADE TALLER AND ALL CAN BE MADE THICKER THAN SHOWN
ALL MOULDINGS ARE MADE TO ORDER AND ARE AVAILABLE IN ANY SPECIES OF WOOD.

O.B. WILLIAMS COMPANY

ESTABLISHED 1889

1939 FIRST AVE. SO. SEATTLE, WASHINGTON 98134 (206) 623-2494 FAX 623-2602

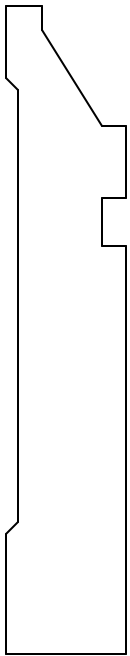

OB1043
5/8 X 3-3/8

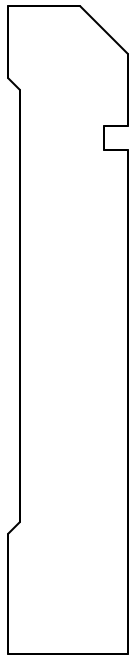

OB1044
5/8 X 3-3/8

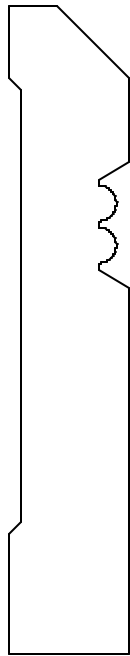

OB1045
5/8 X 3-3/8

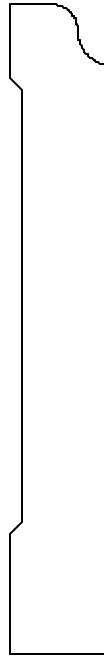

OB1046
1/2 X 3-3/8

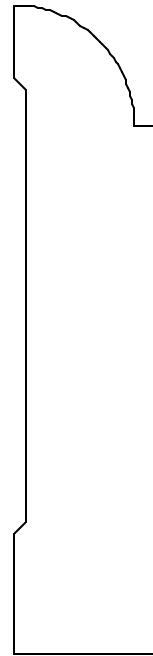

OB1047
3/4 X 3-3/8

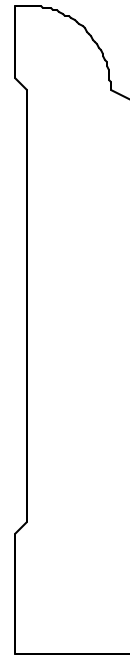

OB1048
5/8 X 3-3/8

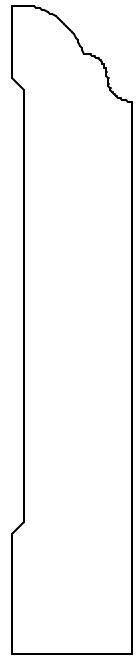

OB1049
5/8 X 3-3/8

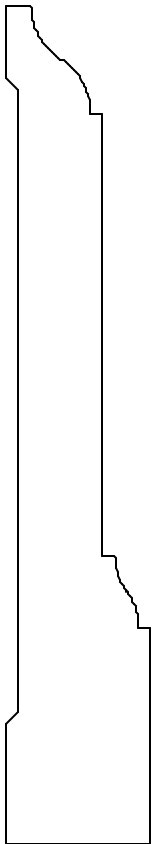

OB1050
3/4 X 4-3/8



OB1051
3/4 X 4-3/8



OB1052
3/4 X 4-3/8

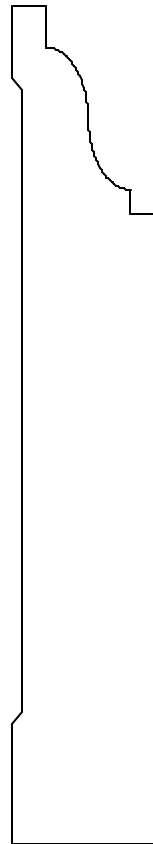

OB1053
3/4 X 4-3/8

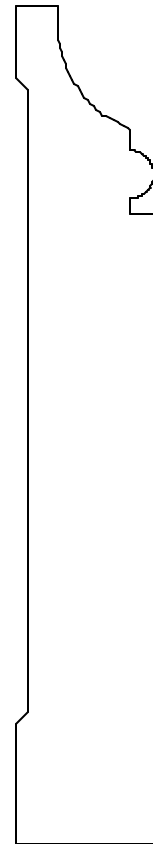

OB1054
3/4 X 4-3/8

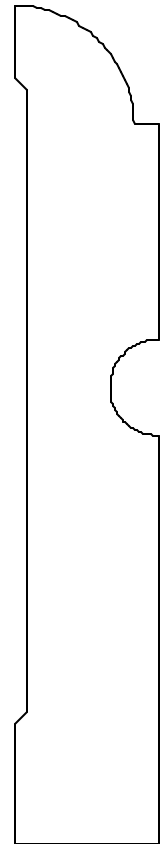

OB1055
3/4 X 4-3/8

MOST OF THE ABOVE MOULDINGS CAN BE MADE TALLER AND ALL CAN BE MADE THICKER THAN SHOWN
ALL MOULDINGS ARE MADE TO ORDER AND ARE AVAILABLE IN ANY SPECIES OF WOOD.

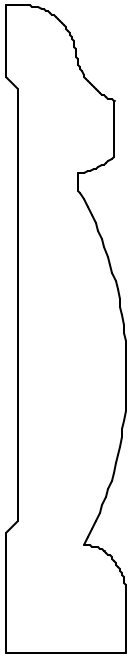

OB1056
5/8 X 3-3/8

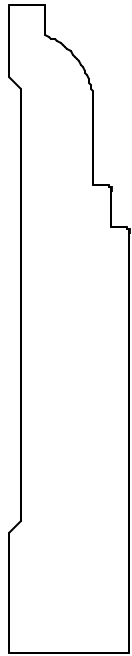

OB1057
5/8 X 3-3/8

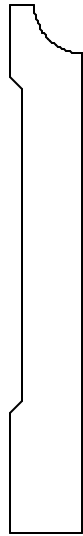

OB1058
3/8 X 2-3/4



OB1059
3/8 X 2-3/4

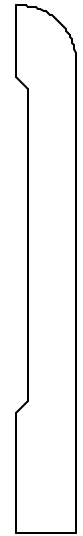

OB1060
5/16 X 2-3/4



OB1061
5/16 X 2-3/4



OB1062
5/16 X 2-3/4

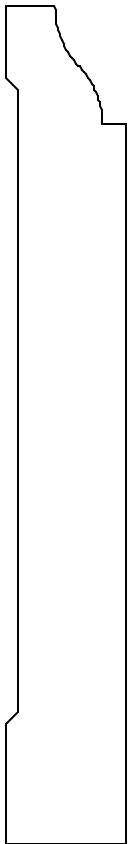

OB1063
5/8 X 4-3/8

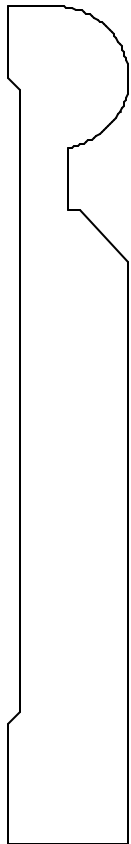

OB1064
5/8 X 4-3/8

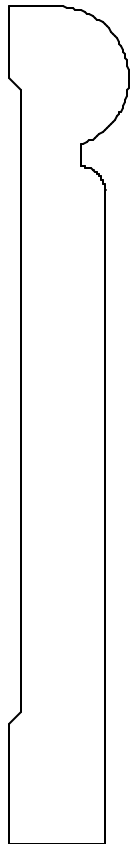

OB1065
5/8 X 4-3/8

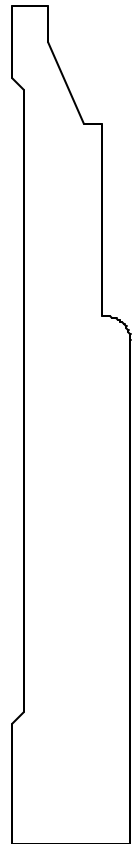

OB1066
5/8 X 4-3/8

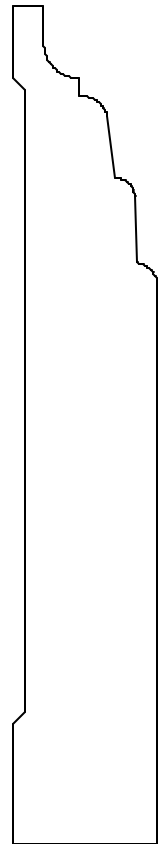

OB1067
3/4 X 4-3/8

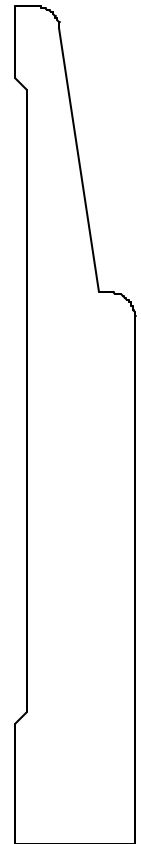

OB1068
5/8 X 4-3/8

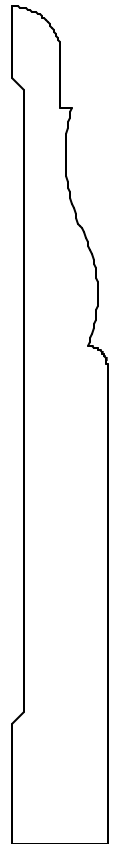

OB1069
1/2 X 4-3/8

MOST OF THE ABOVE MOULDINGS CAN BE MADE TALLER AND ALL CAN BE MADE THICKER THAN SHOWN
ALL MOULDINGS ARE MADE TO ORDER AND ARE AVAILABLE IN ANY SPECIES OF WOOD.



OB1070 7/8 X 5-3/8

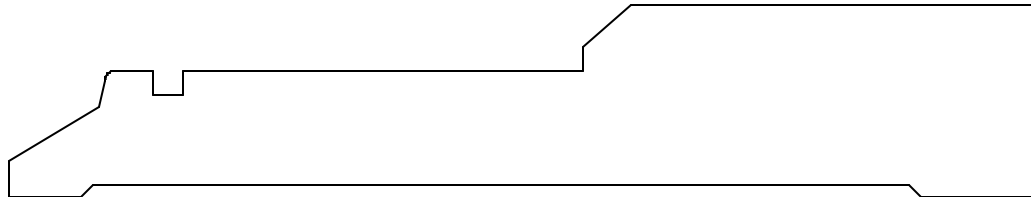

OB1071 1 X 5-3/8

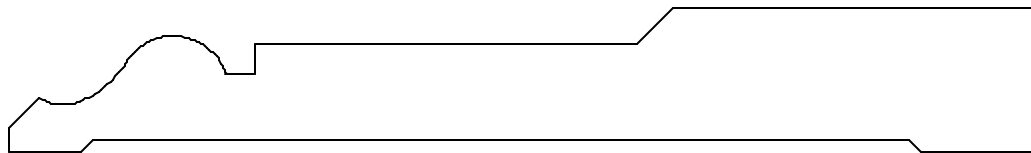

OB1072 3/4 X 5-3/8

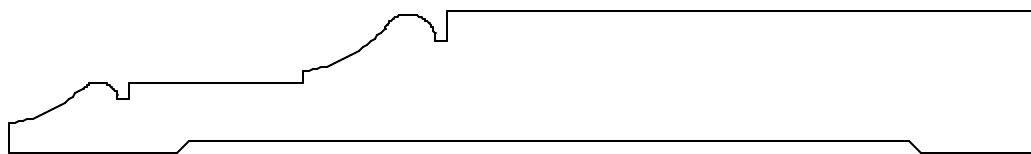

OB1073 3/4 X 5-3/8

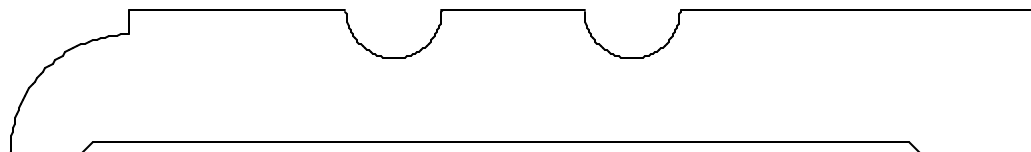

OB1074 3/4 X 5-3/8

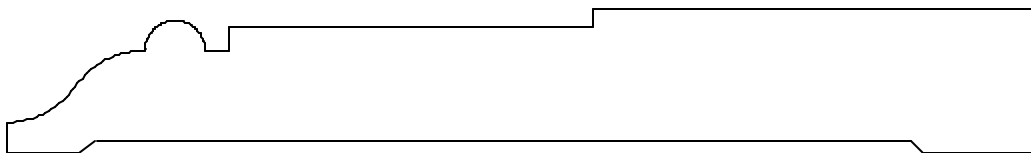

OB1075 3/4 X 5-3/8

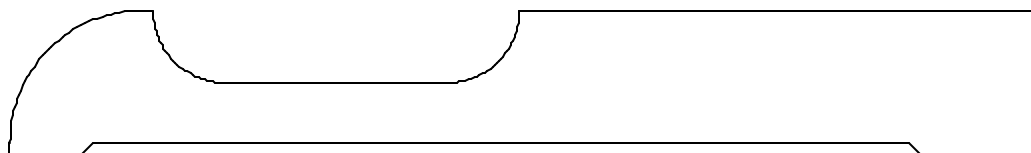

OB1076 3/4 X 5-3/8

MOST OF THE ABOVE MOULDINGS CAN BE MADE TALLER AND ALL CAN BE MADE THICKER THAN SHOWN
ALL MOULDINGS ARE MADE TO ORDER AND ARE AVAILABLE IN ANY SPECIES OF WOOD.

O.B. WILLIAMS COMPANY

ESTABLISHED 1889

1939 FIRST AVE. SO. SEATTLE, WASHINGTON 98134 (206) 623-2494 FAX 623-2602

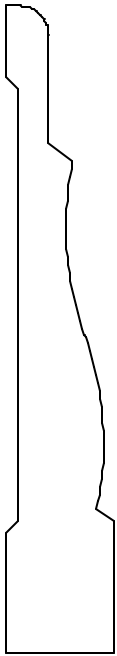

OB1077
9/16 X 3-3/8

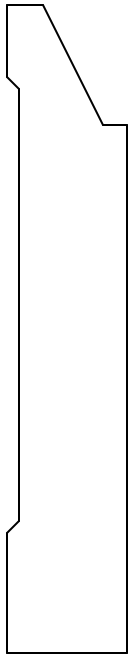

OB1078
5/8 X 3-3/8



OB1079
5/8 X 3-3/8

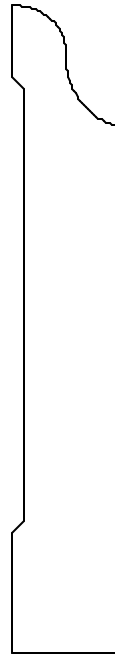

OB1080
9/16 X 3-3/8



OB1081
1/2 X 3-1/8

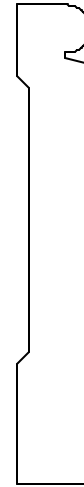

OB1082
3/8 X 2-1/2

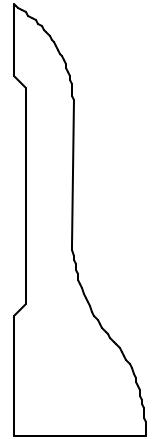

OB1083
11/16 X 2-1/4

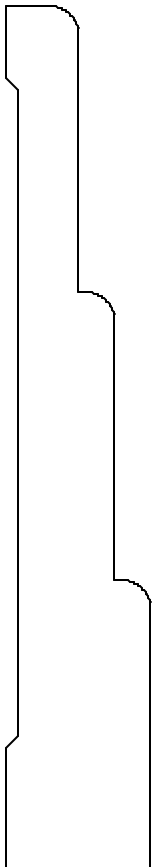

OB1084
3/4 X 4-1/2

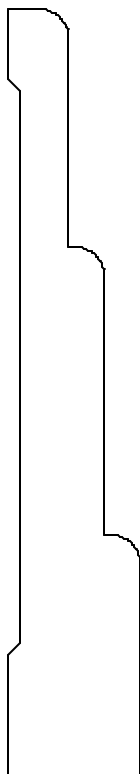

OB1085
11/16 X 4

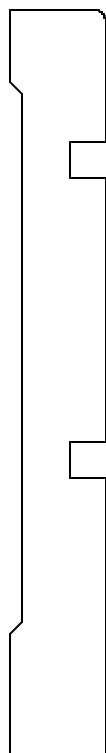

OB1086
1/2 X 3-7/8



OB1087
3/4 X 3-3/4

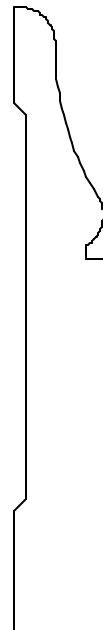

OB1088
1/2 X 3-1/4

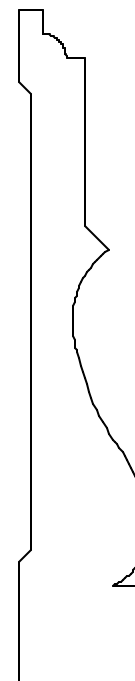

OB1089
5/8 X 3-1/2

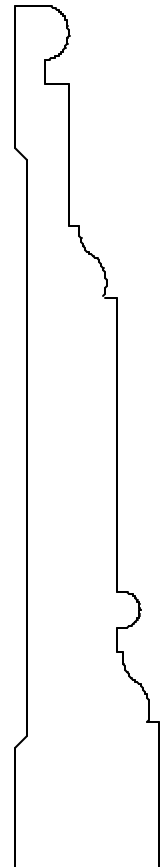

OB1090
3/4 X 4-1/2

MOST OF THE ABOVE MOULDINGS CAN BE MADE TALLER AND ALL CAN BE MADE THICKER THAN SHOWN
ALL MOULDINGS ARE MADE TO ORDER AND ARE AVAILABLE IN ANY SPECIES OF WOOD.

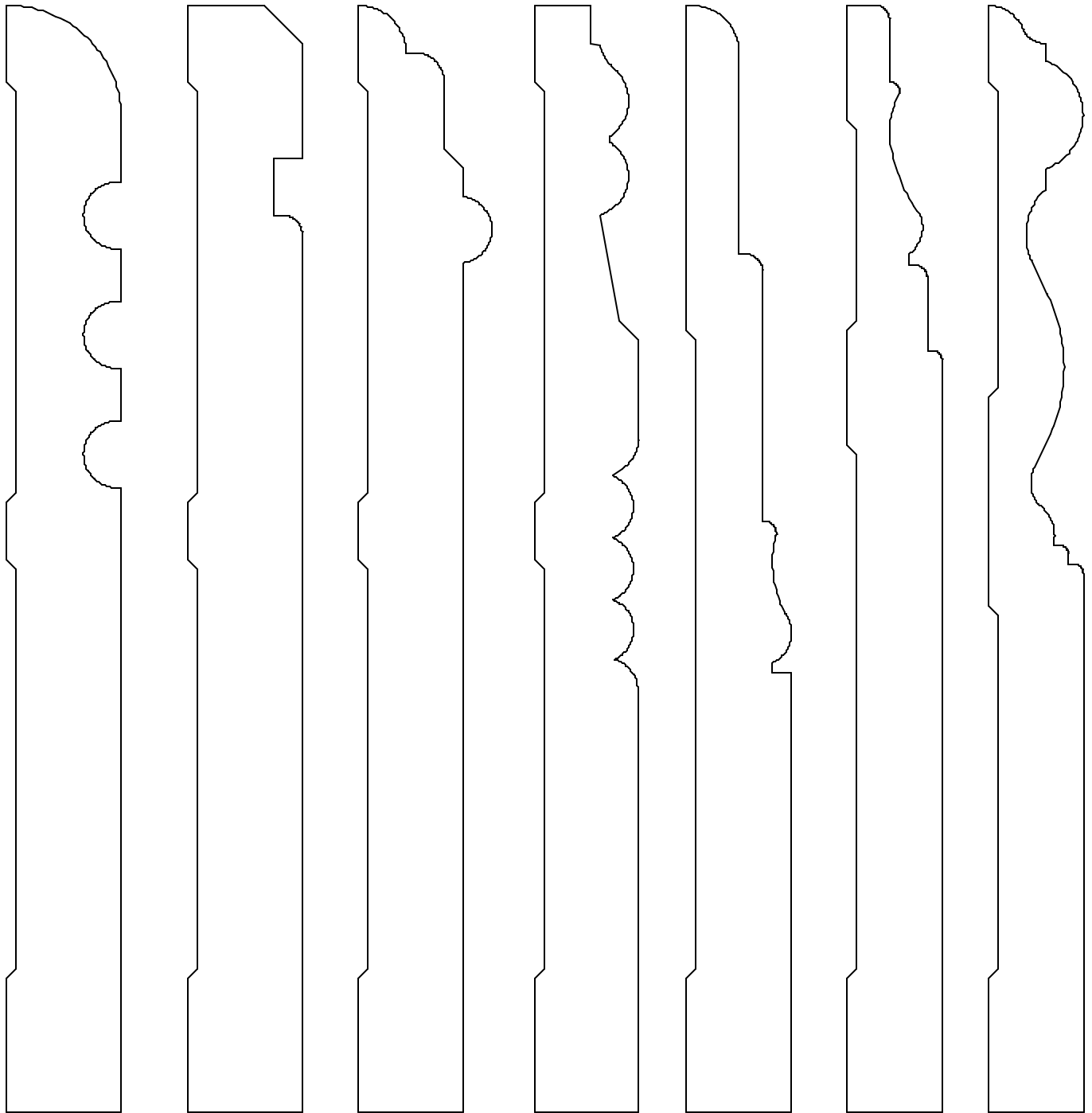

OB1091
3/4 X 7-1/4

OB1092
3/4 X 7-1/4

OB1093
7/8 X 7-1/4

OB1094
11/16 X 7-1/4

OB1095
11/16 X 7-1/4

OB1096
5/8 X 7-1/4

OB1097
5/8 X 7-1/4

ALL ABOVE MOULDINGS CAN BE MADE THICKER THAN SHOWN
ALL MOULDINGS ARE MADE TO ORDER AND ARE AVAILABLE IN ANY SPECIES OF WOOD.

CASINGS

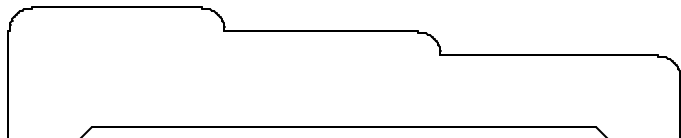

OB1101 11/16 X 3-1/2

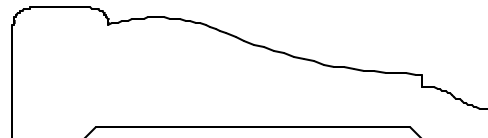

OB1107 11/16 X 2-1/2

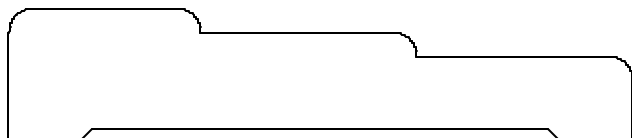

OB1102 11/16 X 3-1/4

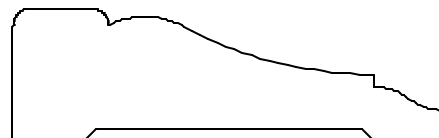

OB1108 11/16 X 2-1/4

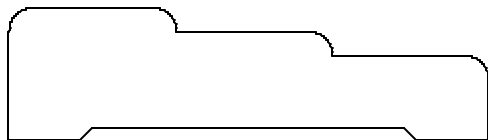

OB1103 11/16 X 2-1/2

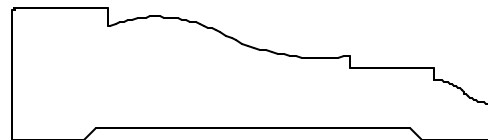

OB1109 11/16 X 2-1/2

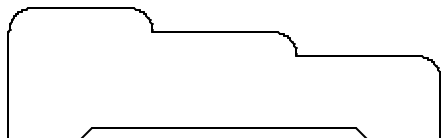

OB1104 11/16 X 2-1/4

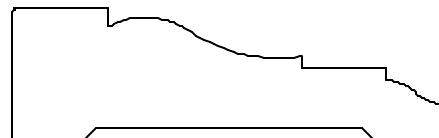

OB1110 11/16 X 2-1/4

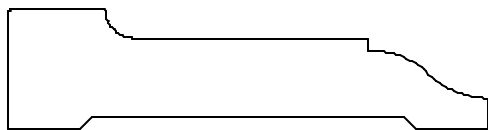

OB1105 5/8 X 2-1/2

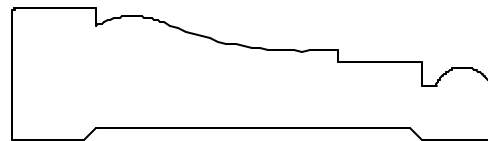

OB1111 11/16 X 2-1/2

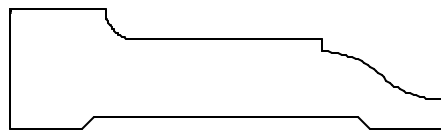

OB1106 5/8 X 2-1/4

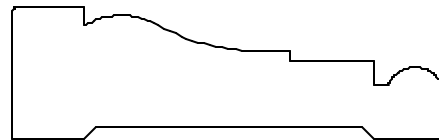

OB1112 11/16 X 2-1/4

ALL ABOVE MOULDINGS CAN BE MADE THICKER THAN SHOWN
ALL MOULDINGS ARE MADE TO ORDER AND ARE AVAILABLE IN ANY SPECIES OF WOOD.

O.B. WILLIAMS COMPANY

ESTABLISHED 1889

1939 FIRST AVE. SO. SEATTLE, WASHINGTON 98134 (206) 623-2494 FAX 623-2602

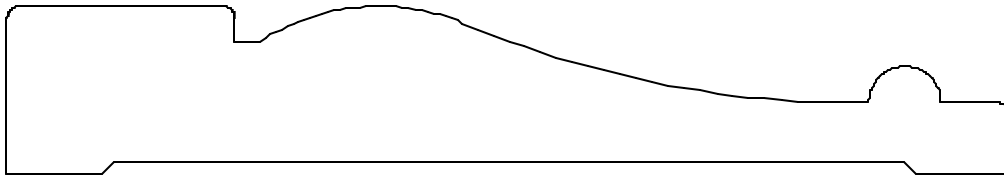

OB1113 7/8 X 5-1/4



OB1114 11/16 X 3-1/2

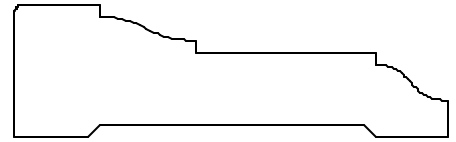

OB1121 11/16 X 2-1/4

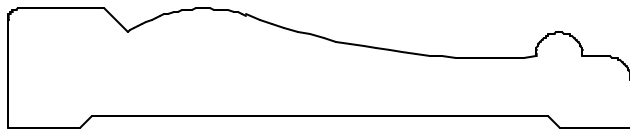

OB1115 5/8 X 3-1/4

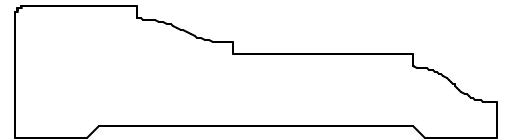

OB1122 11/16 X 2-1/2



OB1116 5/8 X 3-1/4

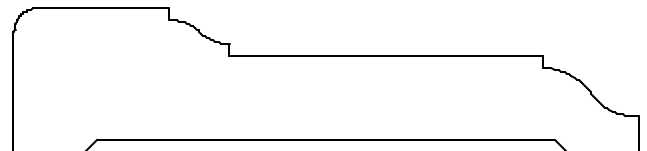

OB1123 3/4 X 3-1/4



OB1117 5/8 X 2-5/8

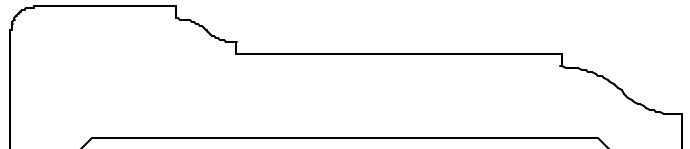

OB1124 3/4 X 3-1/2



OB1118 5/8 X 2-3/8

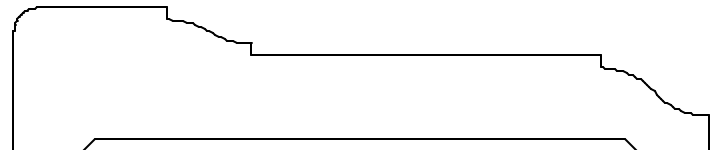

OB1125 3/4 X 3-5/8

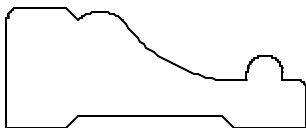

OB1119 5/8 X 1-9/16

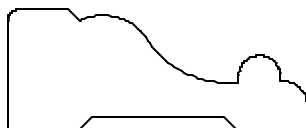

OB1120 5/8 X 1-9/16

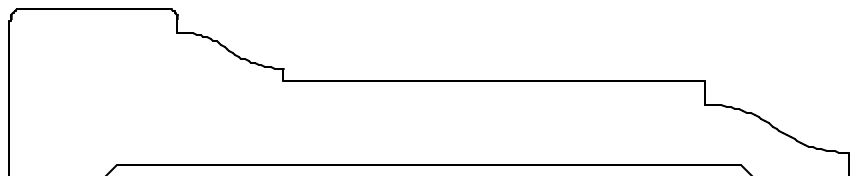

OB1126 7/8 X 4-3/8

ALL ABOVE MOULDINGS CAN BE MADE THICKER THAN SHOWN
ALL MOULDINGS ARE MADE TO ORDER AND ARE AVAILABLE IN ANY SPECIES OF WOOD.

O.B. WILLIAMS COMPANY

ESTABLISHED 1889

1939 FIRST AVE. SO. SEATTLE, WASHINGTON 98134 (206) 623-2494 FAX 623-2602

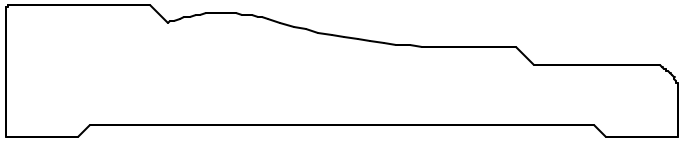

OB1127 11/16 X 3-1/2

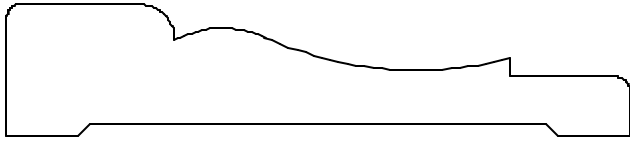

OB1128 11/16 X 3-1/4

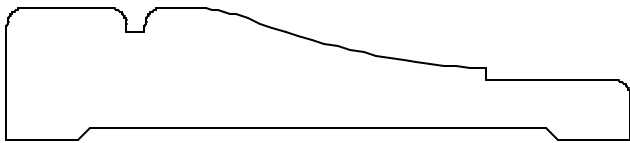

OB1129 11/16 X 3-1/4

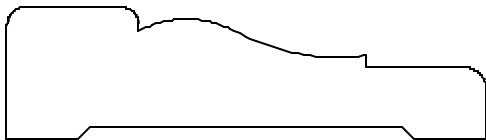

OB1130 11/16 X 2-1/2

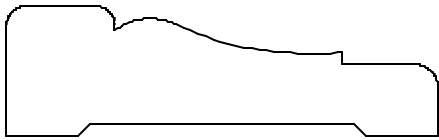

OB1131 11/16 X 2-1/4



OB1132 3/4 X 2-1/2

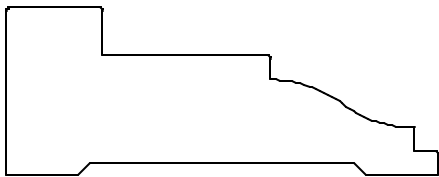

OB1133 7/8 X 2-1/4

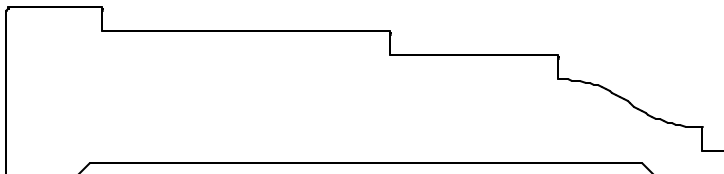

OB1134 7/8 X 3-3/4

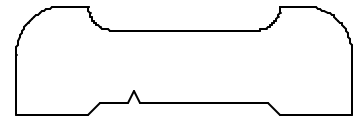

OB1135 9/16 X 1-3/4



OB1136 9/16 X 1-3/4



OB1137 5/8 X 1-3/4

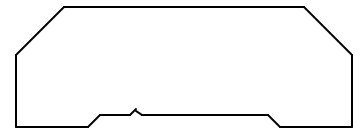

OB1138 5/8 X 1-3/4



OB1139 5/8 X 2-1/2

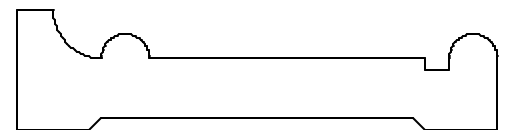

OB1140 5/8 X 2-1/2



OB1141 5/8 X 3-1/2



OB1142 5/8 X 3-1/4

ALL ABOVE MOULDINGS CAN BE MADE THICKER THAN SHOWN
ALL MOULDINGS ARE MADE TO ORDER AND ARE AVAILABLE IN ANY SPECIES OF WOOD.

O.B. WILLIAMS COMPANY

ESTABLISHED 1889

1939 FIRST AVE. SO. SEATTLE, WASHINGTON 98134 (206) 623-2494 FAX 623-2602



OB1143 5/8 X 4

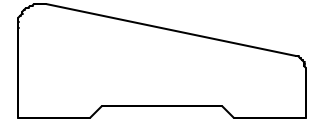

OB1151 5/8 X 1-1/2



OB1144 11/16 X 3-1/2

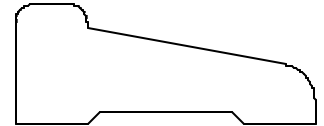

OB1152 5/8 X 1-9/16

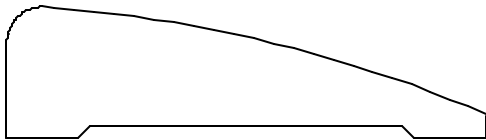

OB1145 11/16 X 2-1/2

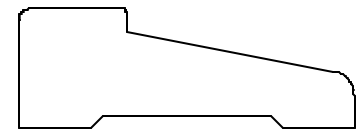

OB1153 5/8 X 1-3/4

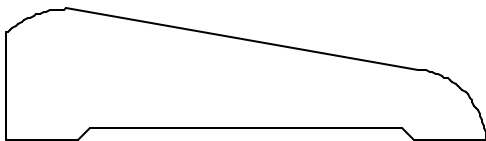

OB1146 11/16 X 2-1/2

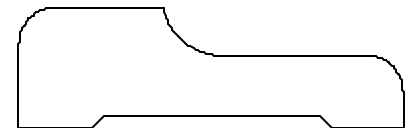

OB1154 5/8 X 2



OB1147 11/16 X 2-1/4

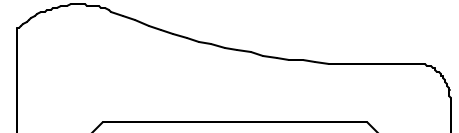

OB1155 11/16 X 2-1/4



OB1148 11/16 X 2-1/4

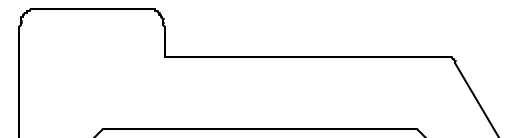

OB1156 11/16 X 2-1/2

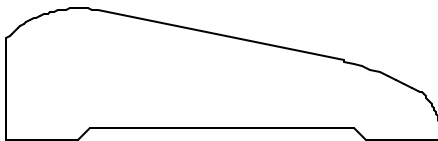

OB1149 11/16 X 2-1/4

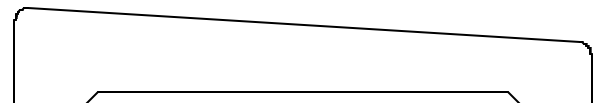

OB1157 1/2 X 3

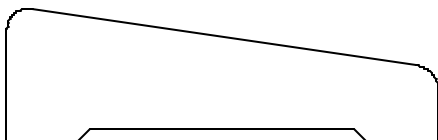

OB1150 11/16 X 2-1/4

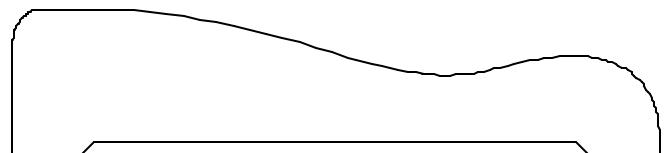

OB1158 3/4 X 3-3/8

ALL ABOVE MOULDINGS CAN BE MADE THICKER THAN SHOWN
ALL MOULDINGS ARE MADE TO ORDER AND ARE AVAILABLE IN ANY SPECIES OF WOOD.

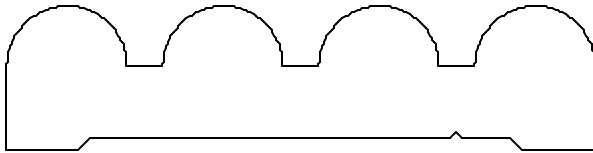

OB1159 3/4 X 3-1/16

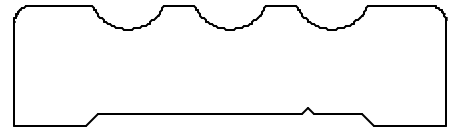

OB1167 5/8 X 2-1/4

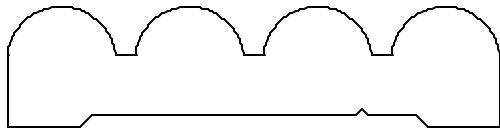

OB1160 5/8 X 2-9/16

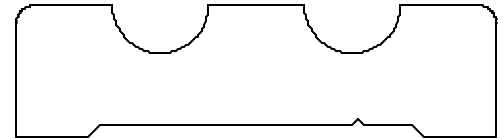

OB1168 11/16 X 2-1/2

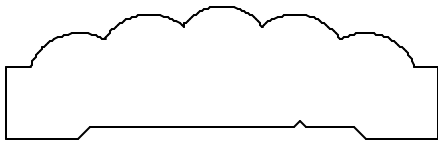

OB1161 11/16 X 2-1/4



OB1169 5/8 X 3-1/4

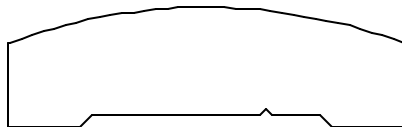

OB1162 5/8 X 2-1/16

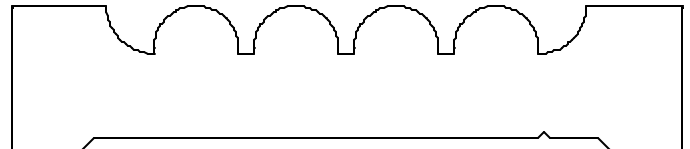

OB1170 3/4 X 3-1/2

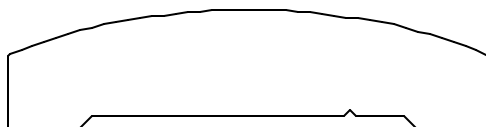

OB1163 5/8 X 2-1/2

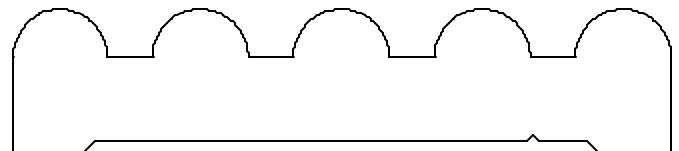

OB1171 3/4 X 3-7/16

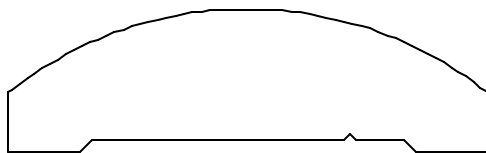

OB1164 3/4 X 2-1/2

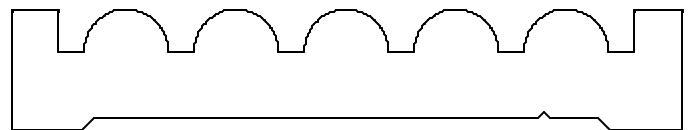

OB1172 5/8 X 3-1/2

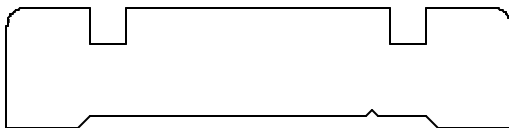

OB1165 5/8 X 2-5/8

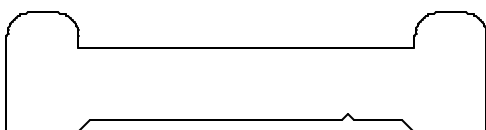

OB1166 5/8 X 2-1/2

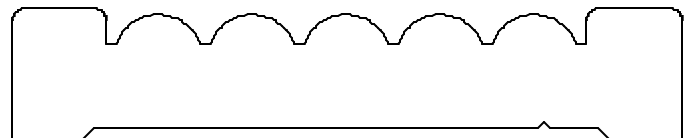

OB1173 11/16 X 3-1/2

ALL ABOVE MOULDINGS CAN BE MADE THICKER THAN SHOWN
ALL MOULDINGS ARE MADE TO ORDER AND ARE AVAILABLE IN ANY SPECIES OF WOOD.

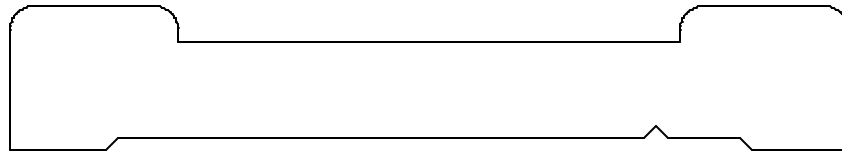

OB1174 3/4 X 4-3/8

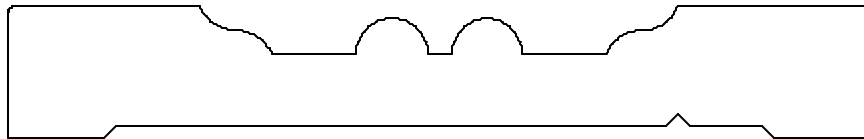

OB1175 11/16 X 4-1/2

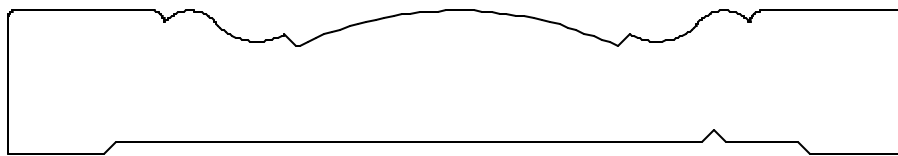

OBB1176 3/4 X 4-11/16

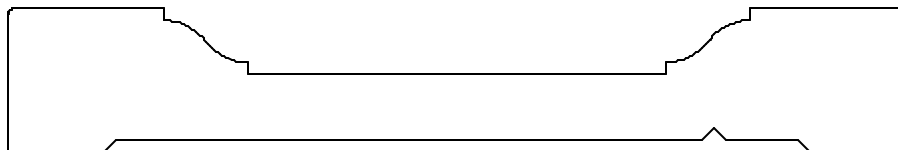

OB1177 3/4 X 4-11/16



OB1178 3/4 X 5-1/4

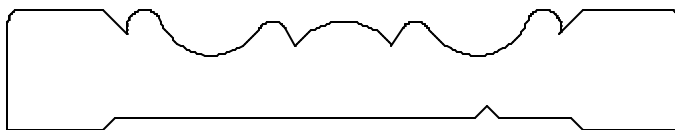

OB1179 5/8 X 3-1/2

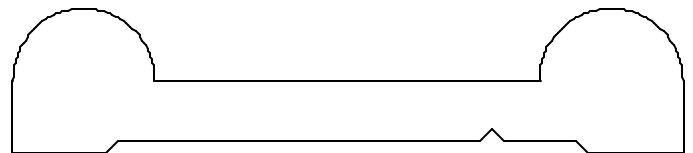

OB1182 3/4 X 3-1/2

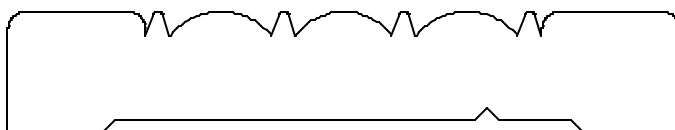

OB1180 5/8 X 3-1/2

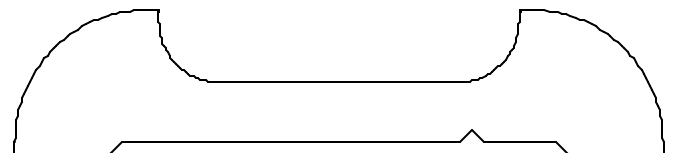

OB1183 3/4 X 3-3/8

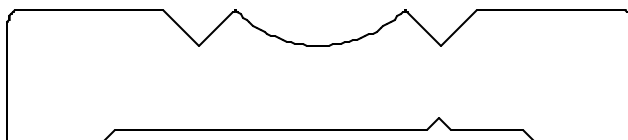

OB1181 11/16 X 3-1/4

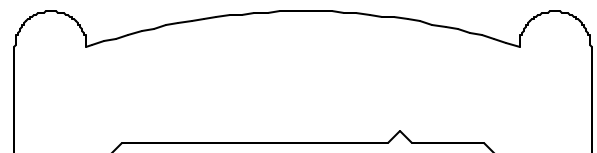

OB1184 3/4 X 3

ALL ABOVE MOULDINGS CAN BE MADE THICKER THAN SHOWN
ALL MOULDINGS ARE MADE TO ORDER AND ARE AVAILABLE IN ANY SPECIES OF WOOD.

O.B. WILLIAMS COMPANY

ESTABLISHED 1889

1939 FIRST AVE. SO. SEATTLE, WASHINGTON 98134 (206) 623-2494 FAX 623-2602

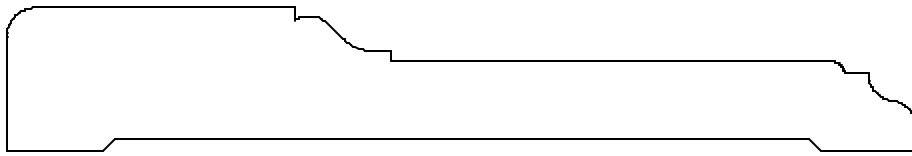

OB1185 3/4 X 4-3/4

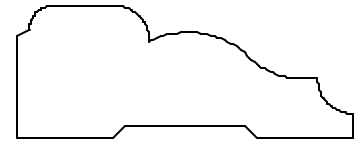

OB1192 11/16 X 1-3/4

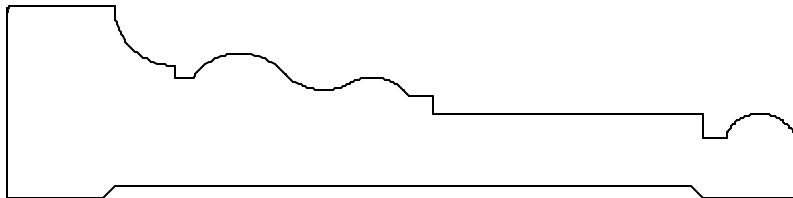

OB1186 1 X 4-1/8

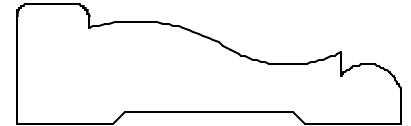

OB1193 5/8 X 2

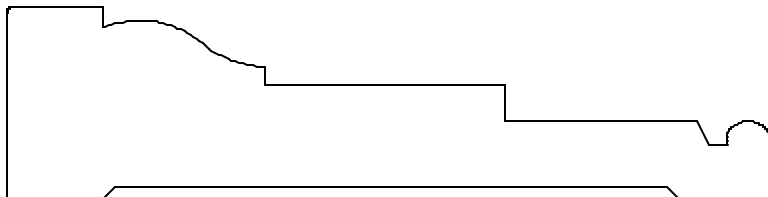

OB1187 1 X 4

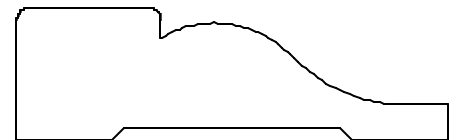

OB1194 11/16 X 2-1/4

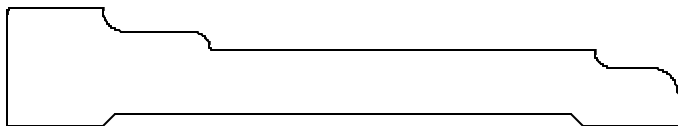

OB1188 5/8 X 3-1/2

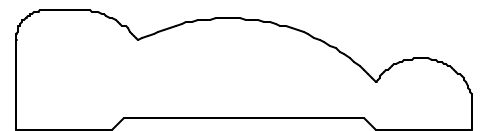

OB1195 5/8 X 2-3/8

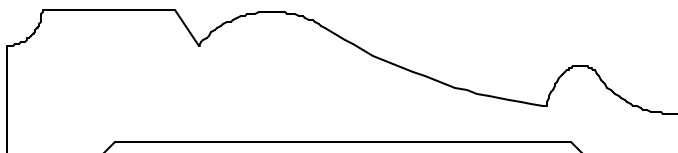

OB1189 3/4 X 3-1/2

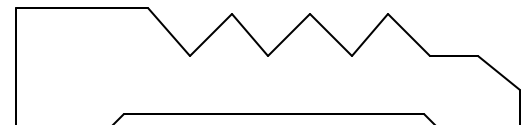

OB1196 5/8 X 2-5/8

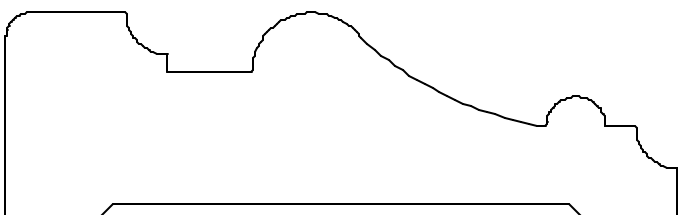

OB1190 1-1/16 X 3-1/2

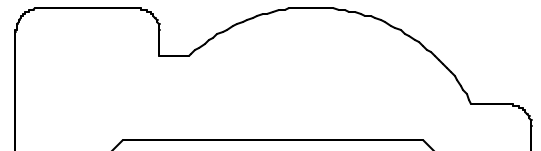

OB1197 3/4 X 2-11/16



OB1191 3/4 X 3

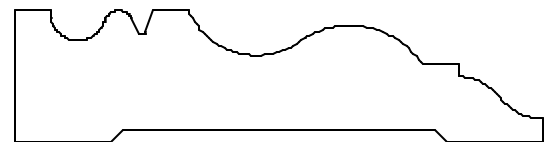

OB1198 11/16 X 2-3/4

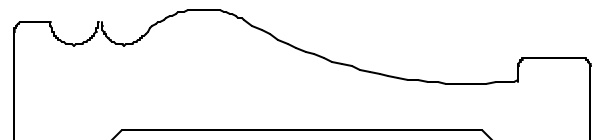

OB1199 11/16 X 3

ALL ABOVE MOULDINGS CAN BE MADE THICKER THAN SHOWN
ALL MOULDINGS ARE MADE TO ORDER AND ARE AVAILABLE IN ANY SPECIES OF WOOD.

CROWN MOULDINGS

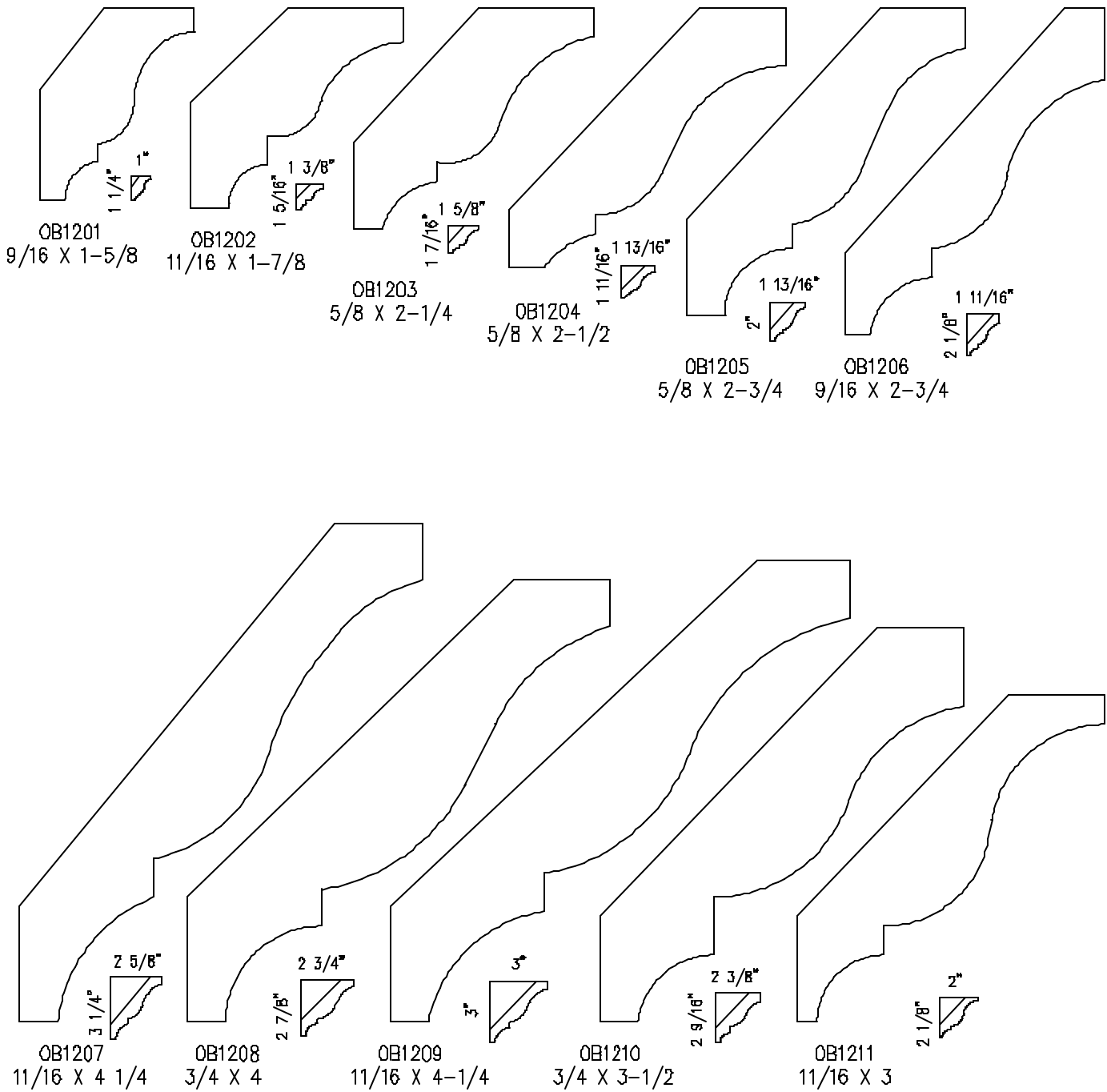

ALL MOULDINGS ARE MADE TO ORDER AND ARE AVAILABLE IN ANY SPECIES OF WOOD.

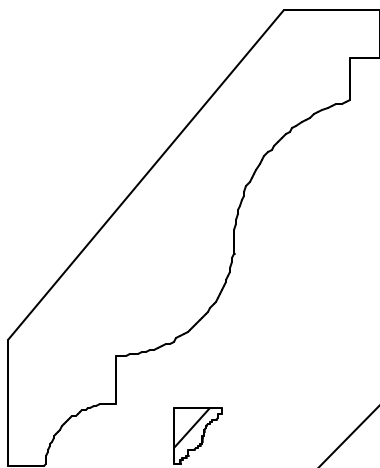

OB1212
1 1/16 X 3-1/8

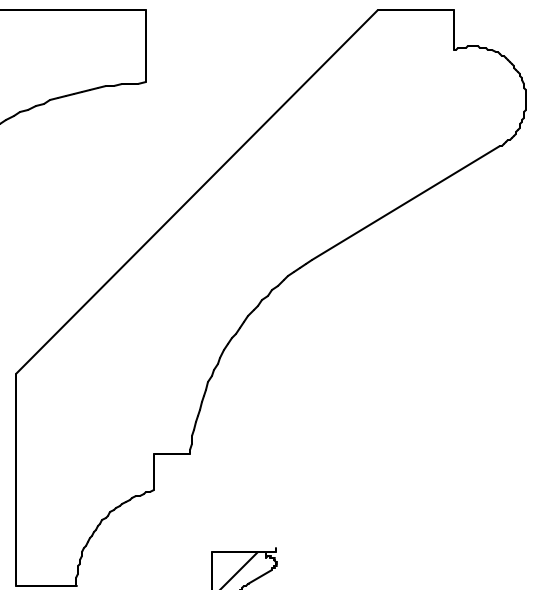

OB1214
1 X 3-3/4

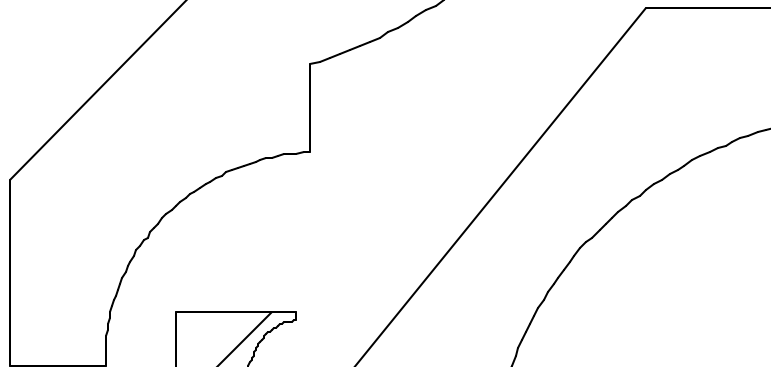

OB1213
1 X 7

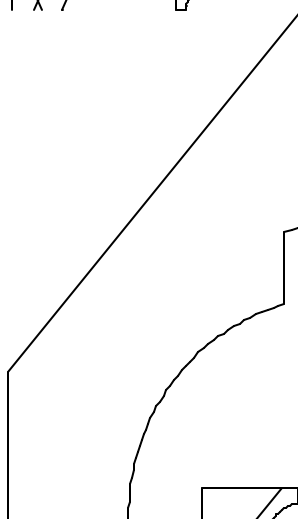

OB1215
1 X 6-1/4

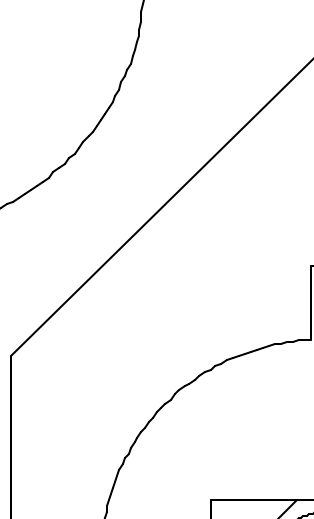

OB1216
1 X 6-1/4

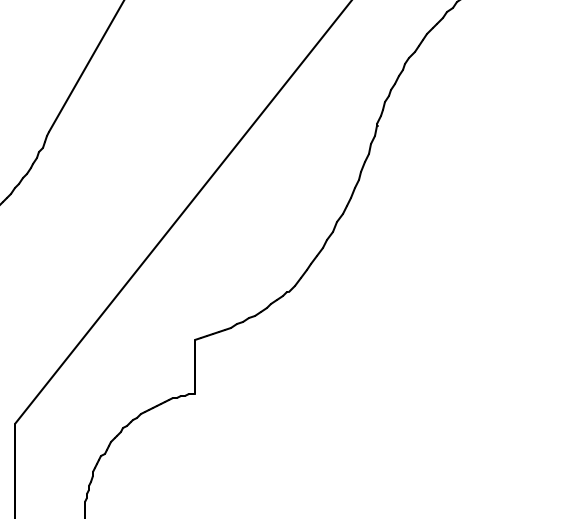

OB1217
1 1/16 X 4-5/8

ALL MOULDINGS ARE MADE TO ORDER AND ARE AVAILABLE IN ANY SPECIES OF WOOD.

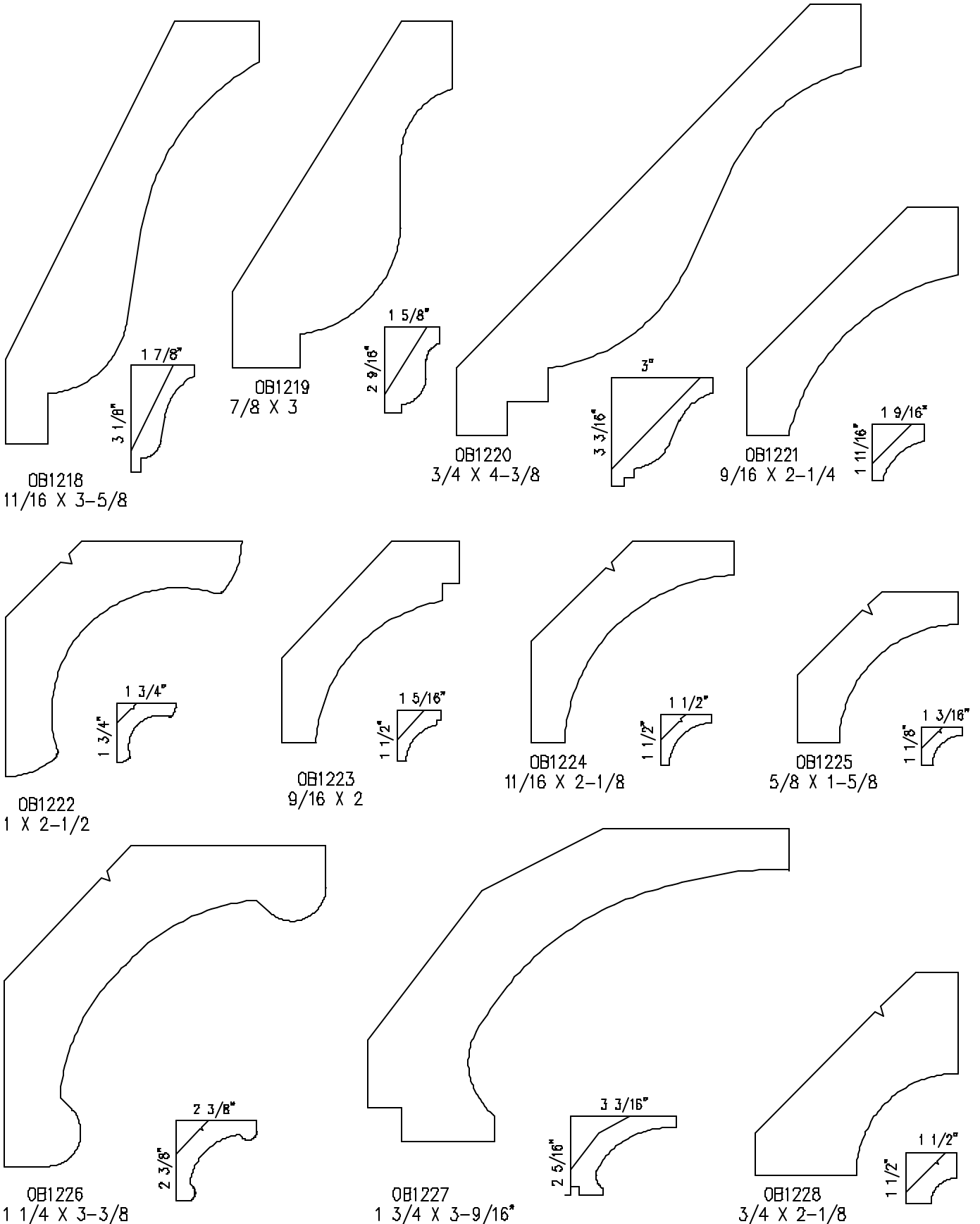

ALL MOULDINGS ARE MADE TO ORDER AND ARE AVAILABLE IN ANY SPECIES OF WOOD.

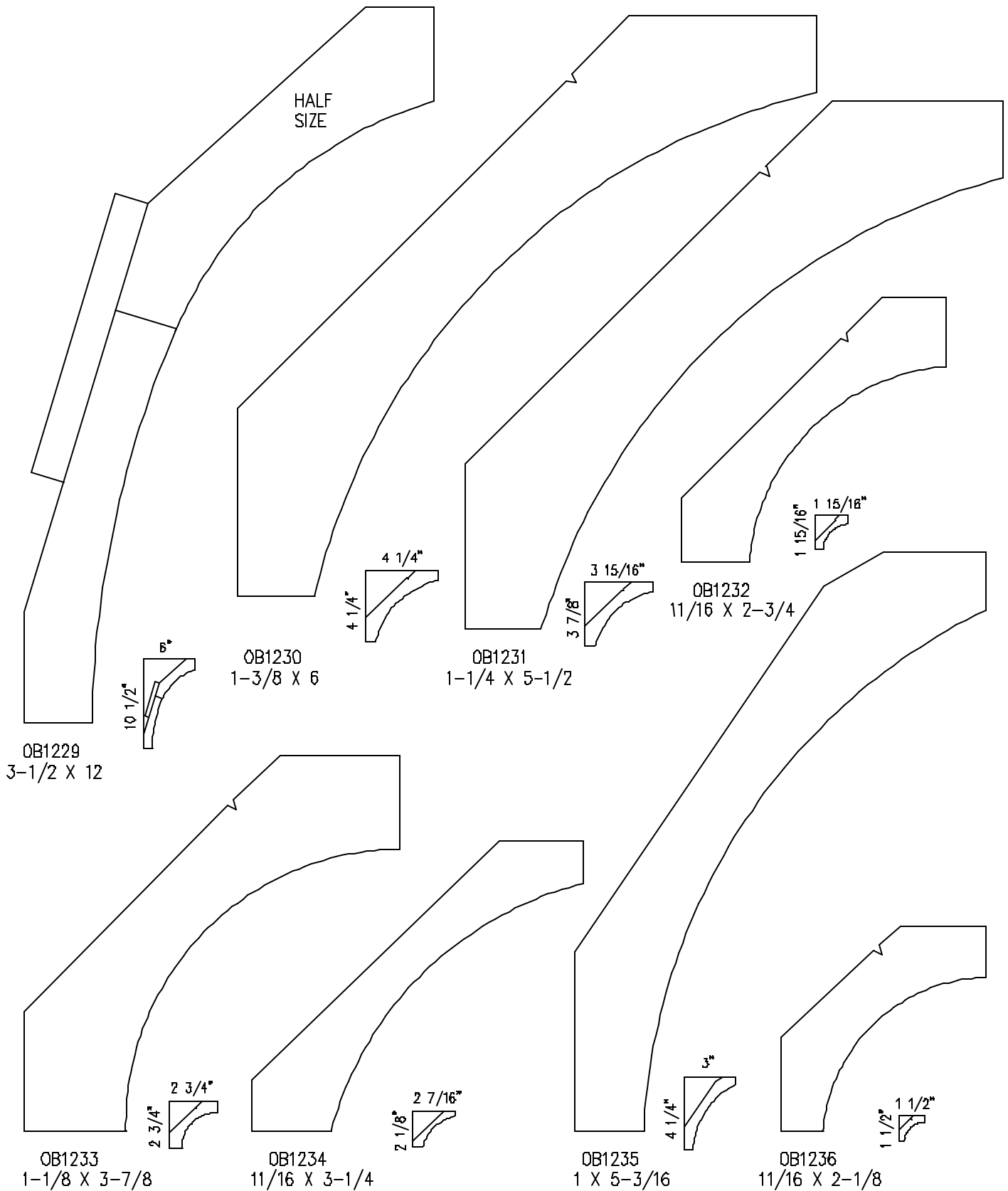

ALL MOULDINGS ARE MADE TO ORDER AND ARE AVAILABLE IN ANY SPECIES OF WOOD.

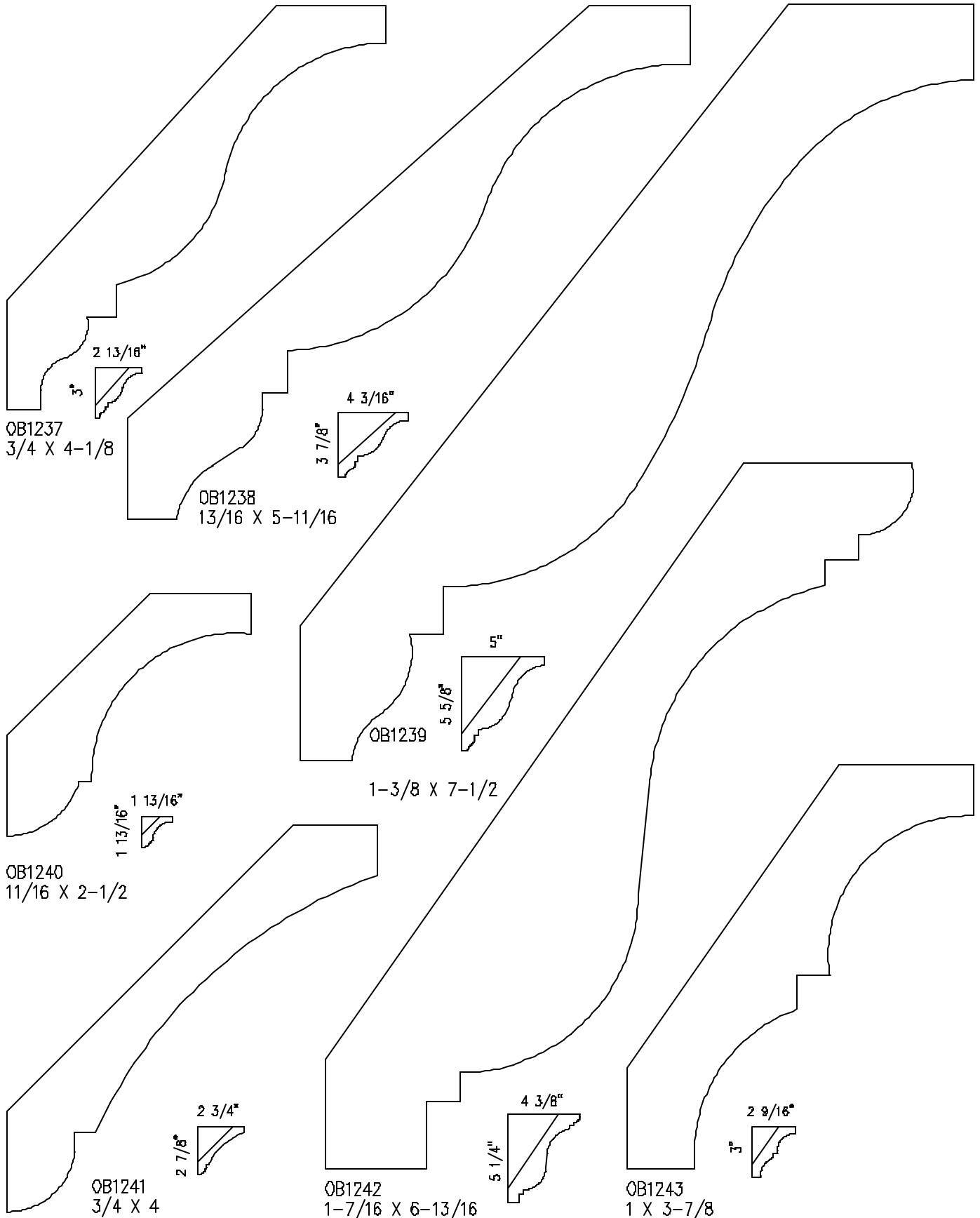

ALL MOULDINGS ARE MADE TO ORDER AND ARE AVAILABLE IN ANY SPECIES OF WOOD.

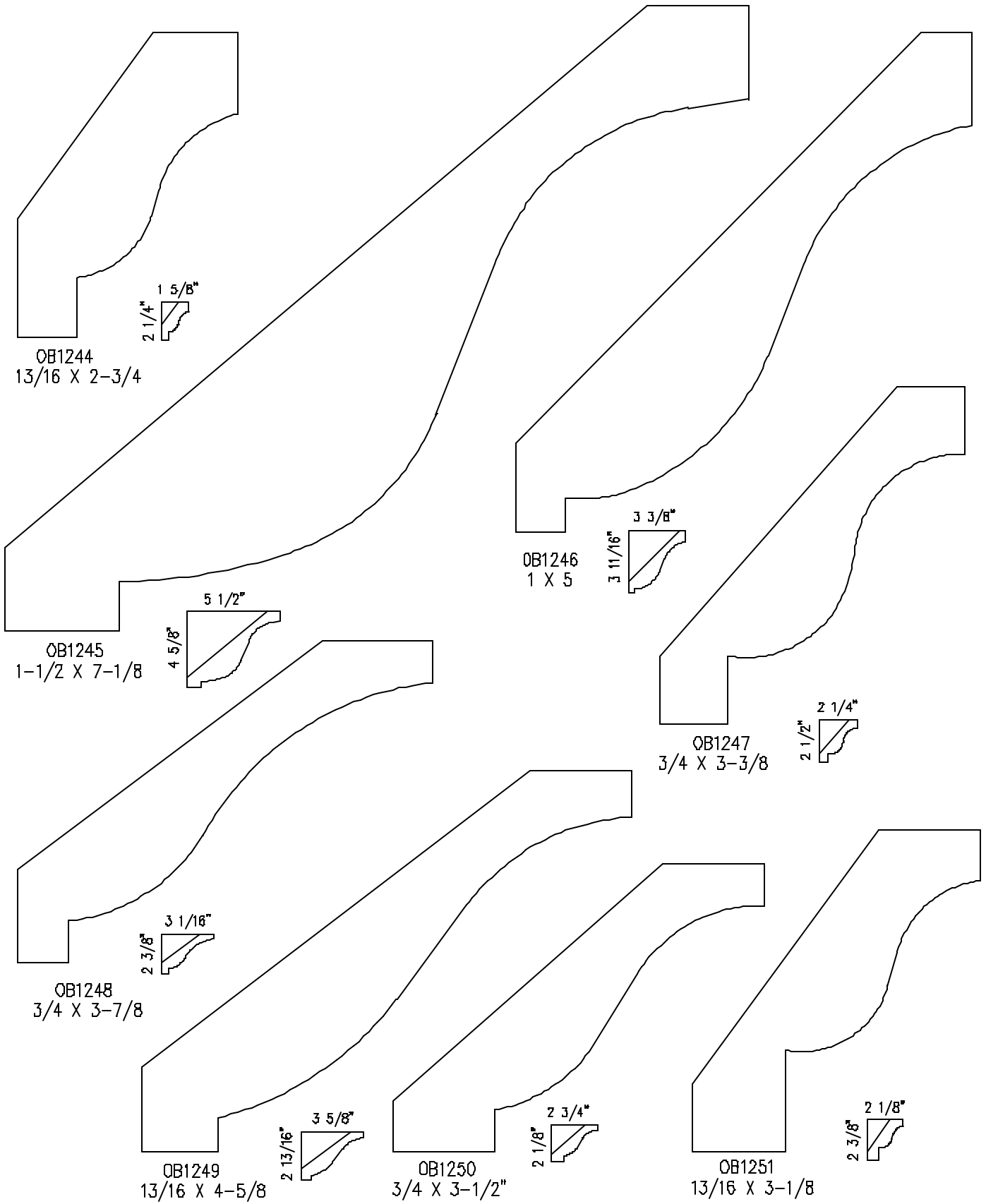

ALL MOULDINGS ARE MADE TO ORDER AND ARE AVAILABLE IN ANY SPECIES OF WOOD.

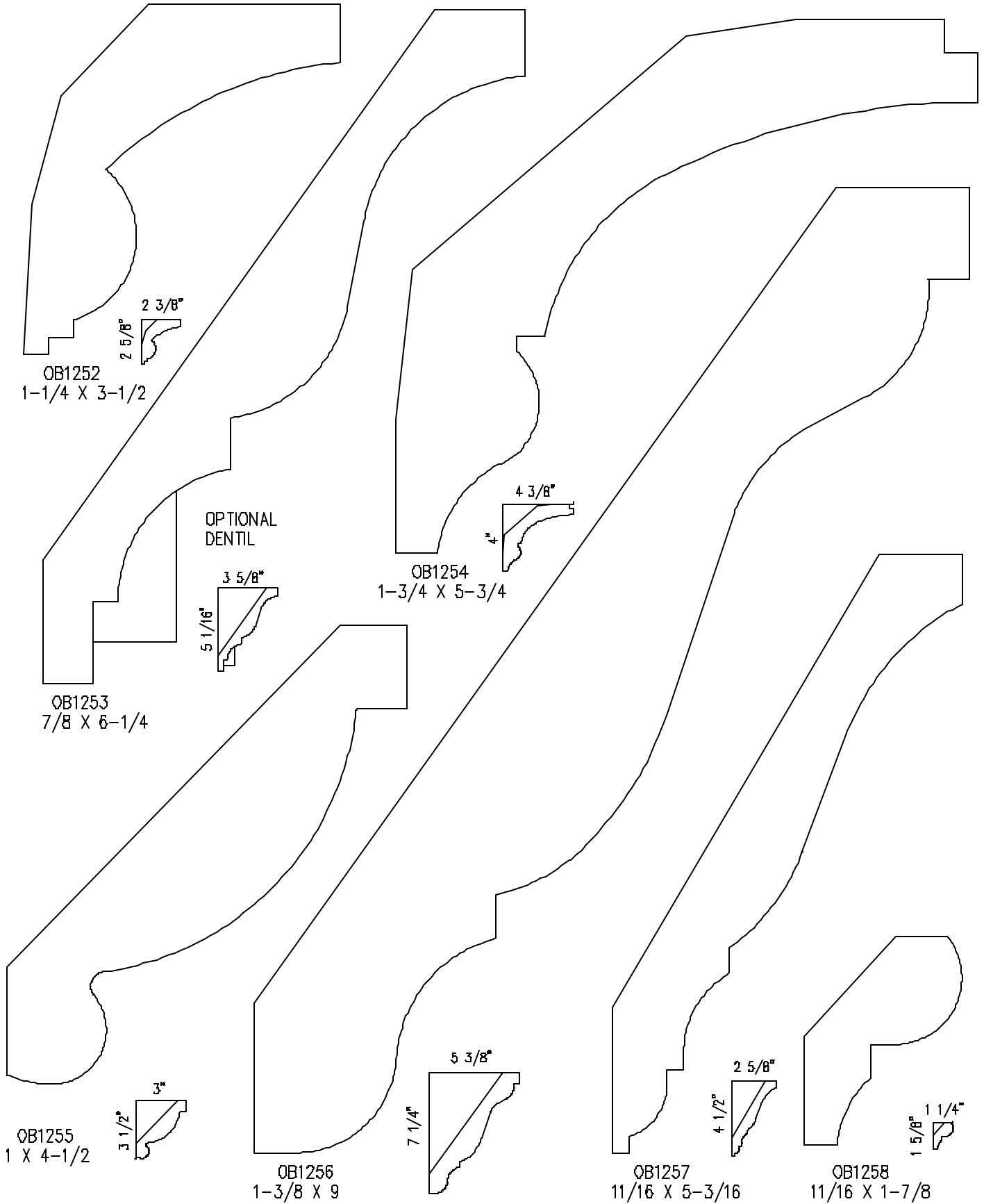

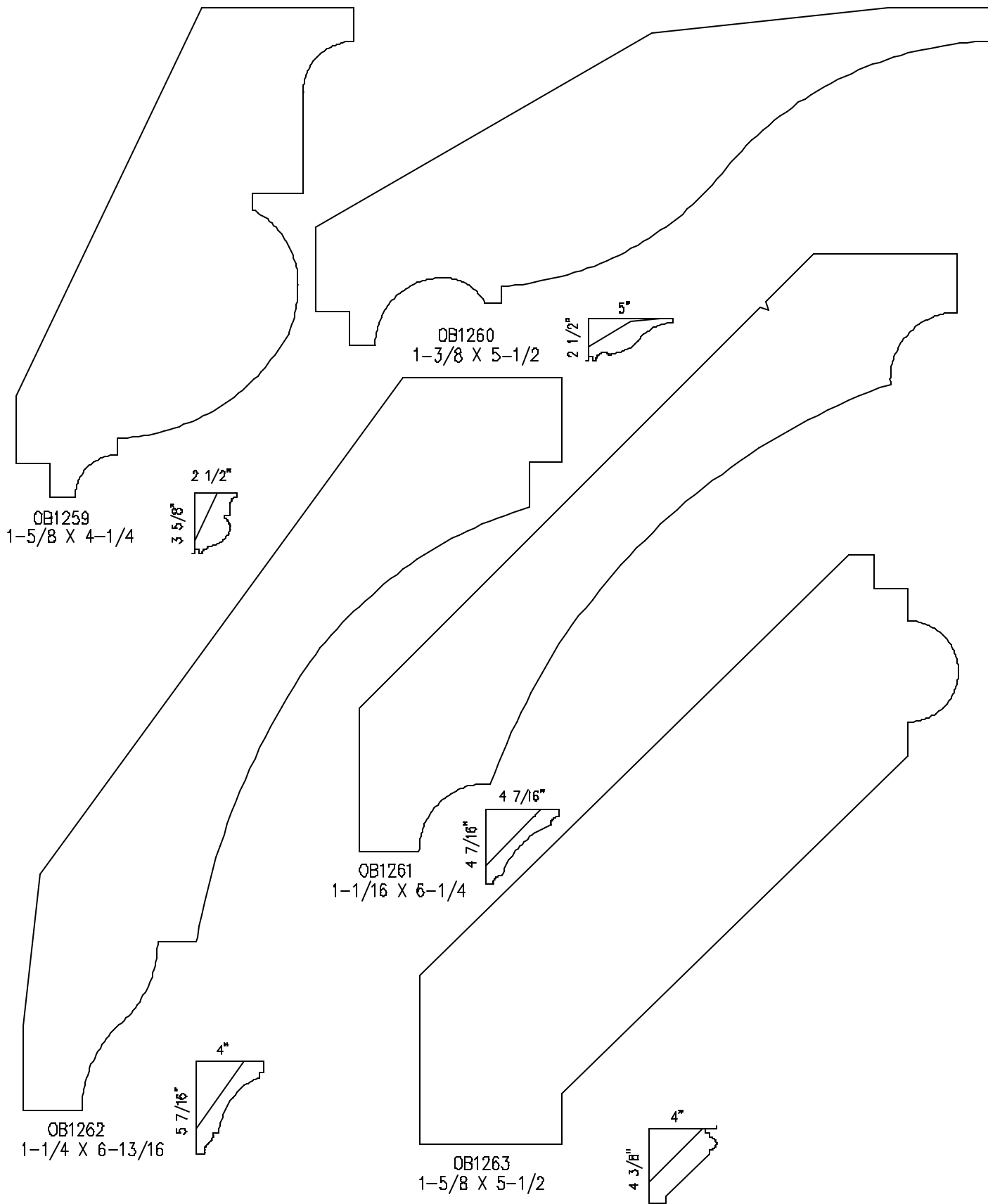

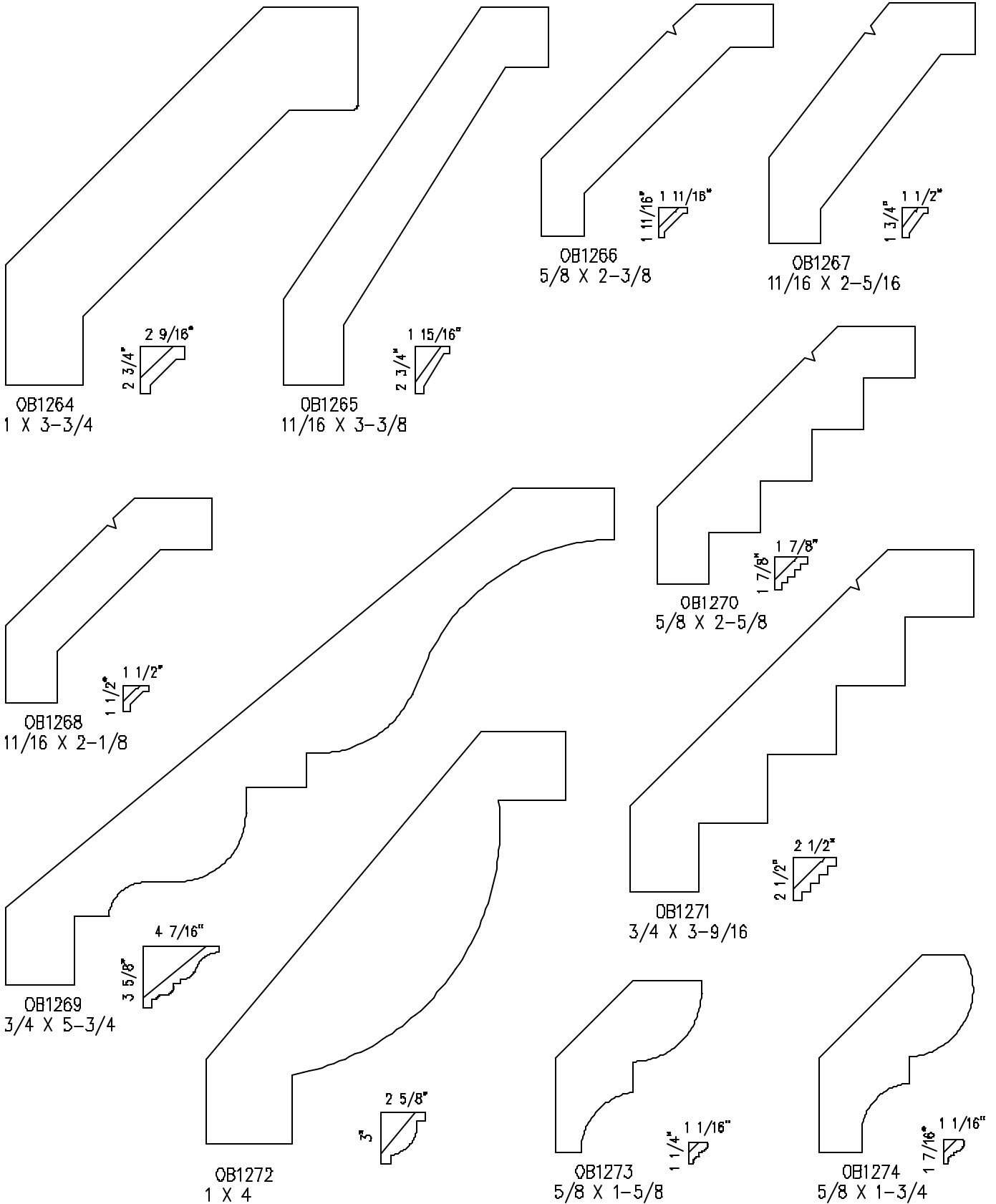

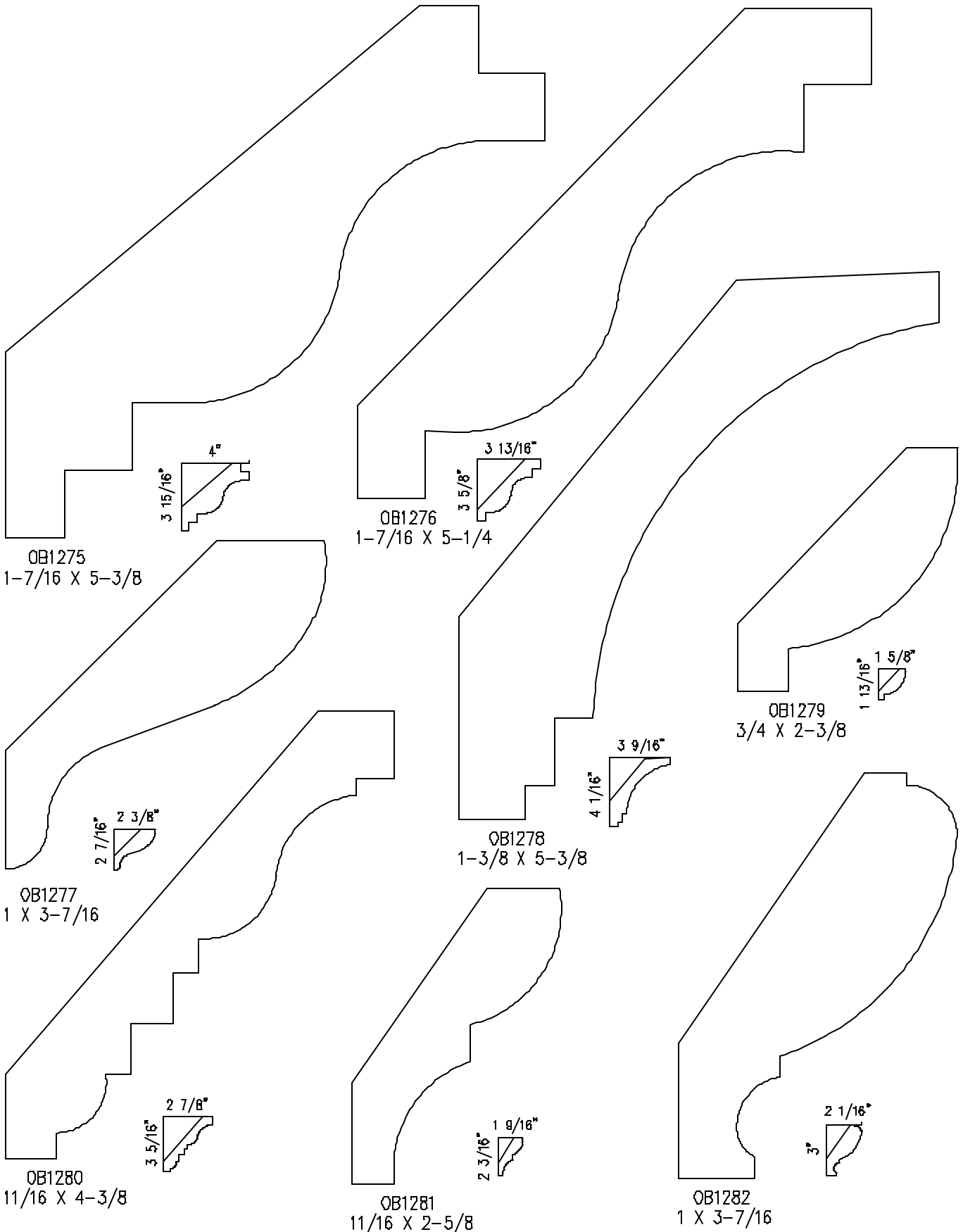

O.B. WILLIAMS COMPANY

ESTABLISHED 1889

1939 FIRST AVE. SO. SEATTLE, WASHINGTON 98134 (206) 623-2494 FAX 623-2602

OB1283
13/16 X 3

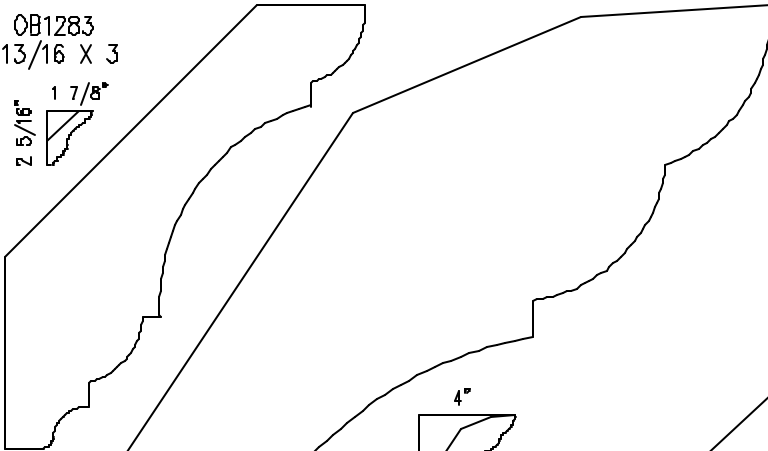
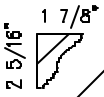

OB1285
1-5/8 X 8-3/4

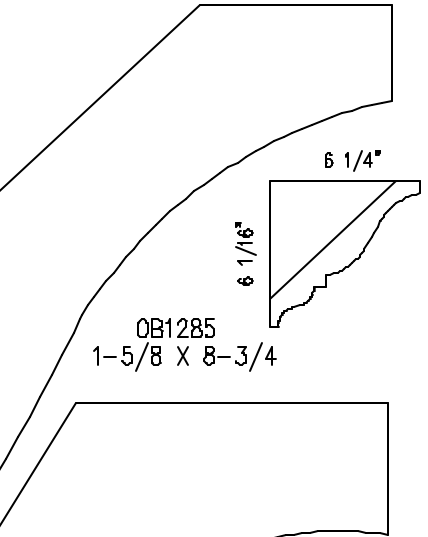
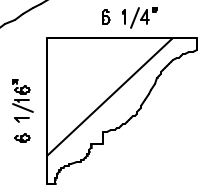

OB1284
1-3/4 X 7-1/4

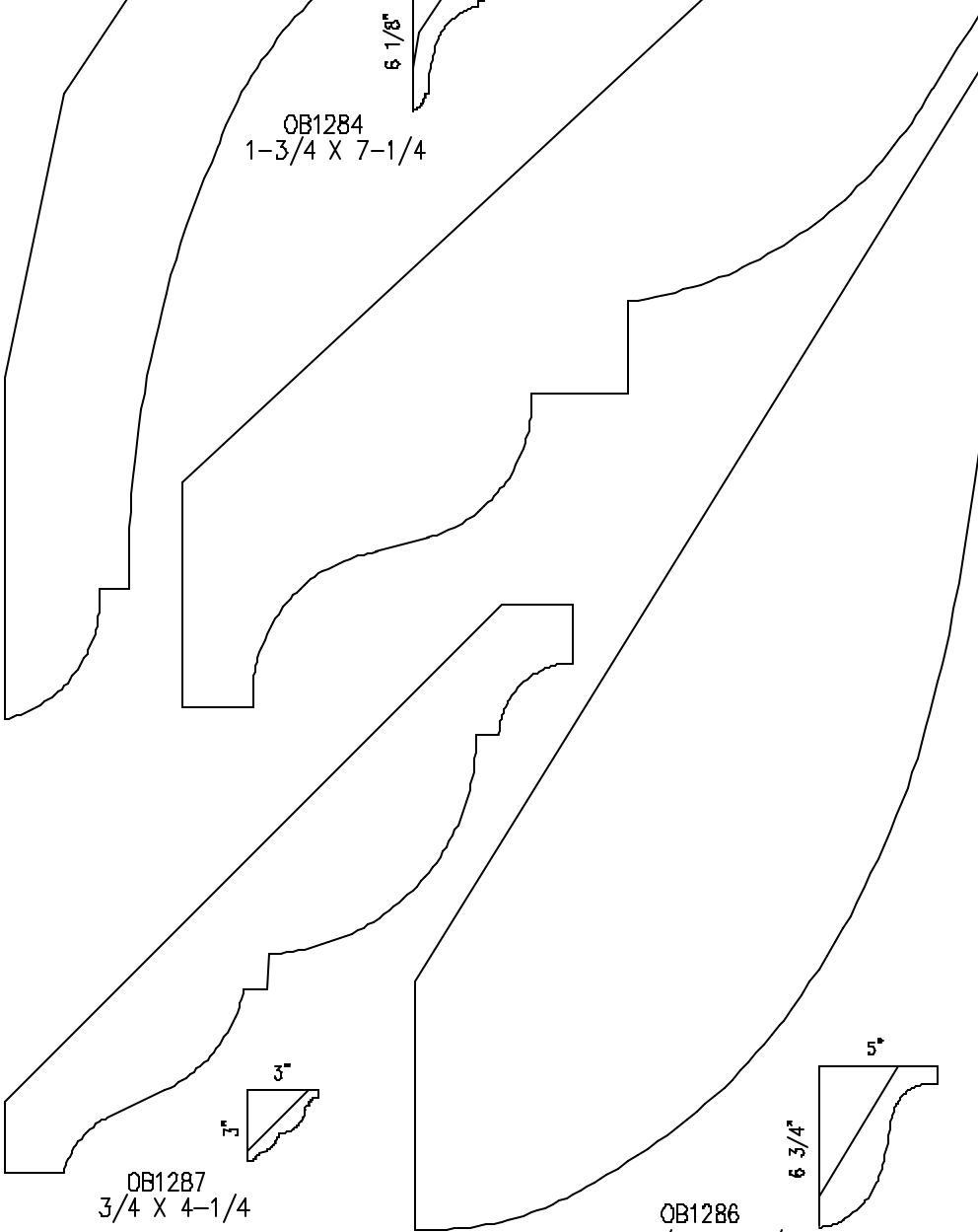

OB1288
7/8 X 4-7/8

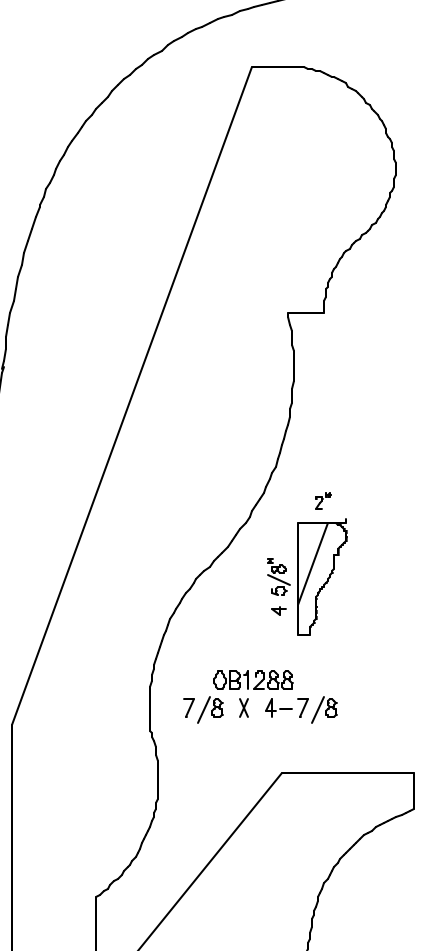

OB1287
3/4 X 4-1/4

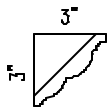

OB1286
1-3/4 X 8-5/8

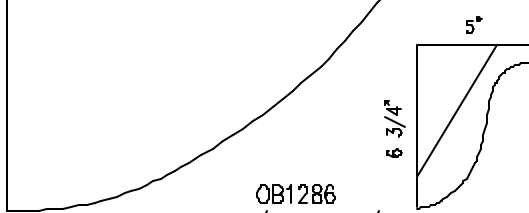

OB1289
3/4 X 2-3/4

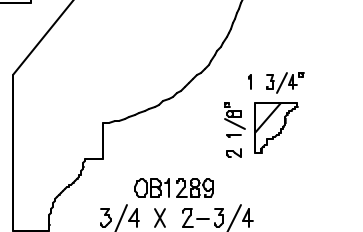
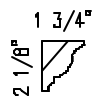

ALL MOULDINGS ARE MADE TO ORDER AND ARE AVAILABLE IN ANY SPECIES OF WOOD.

O.B. WILLIAMS COMPANY

ESTABLISHED 1889

1939 FIRST AVE. SO. SEATTLE, WASHINGTON 98134 (206) 623-2494 FAX 623-2602

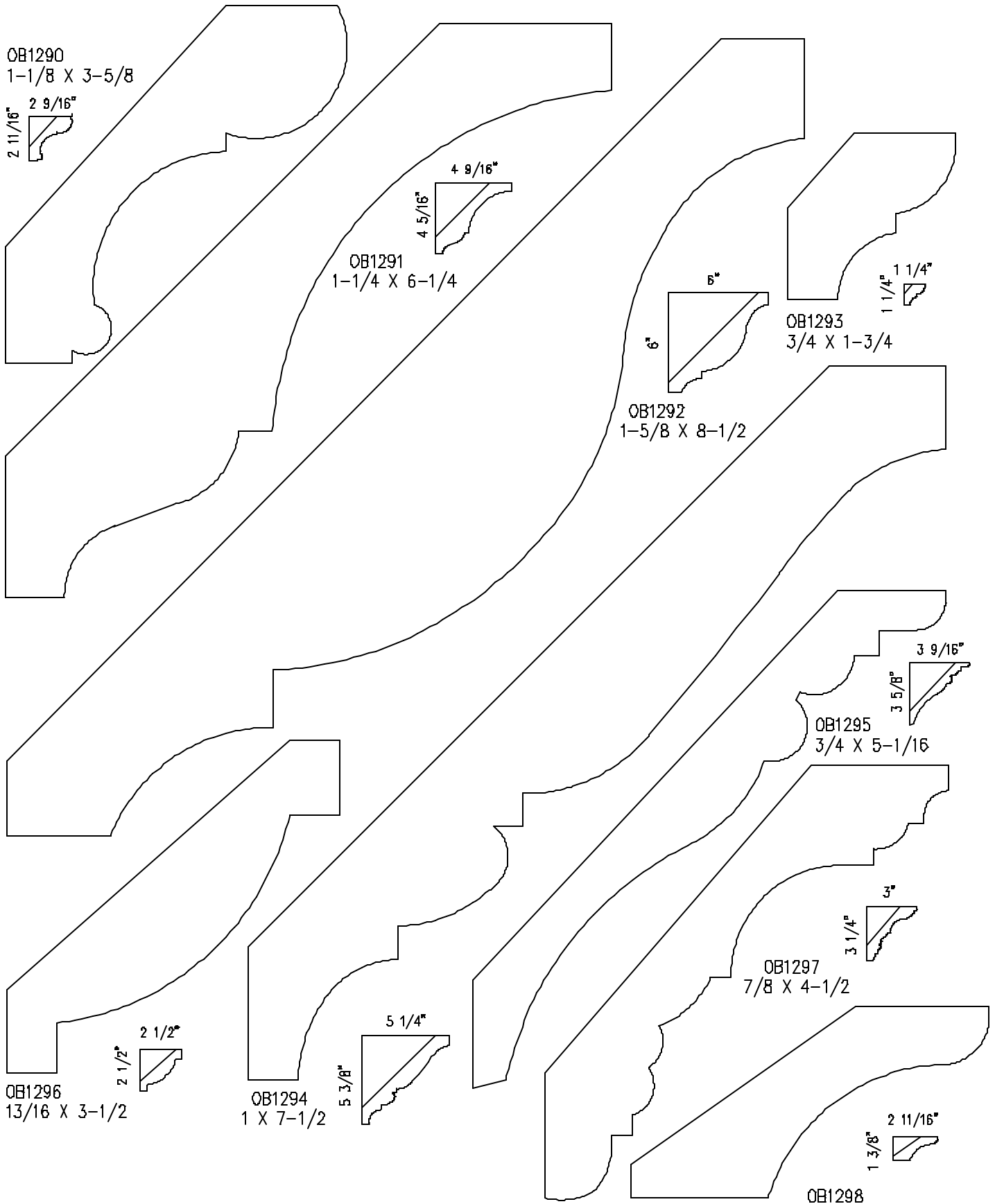

BRICK/SHAKE MOULDINGS

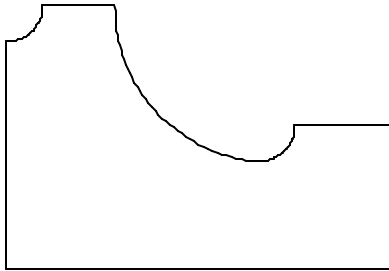

OB1301 1-3/8 X 2

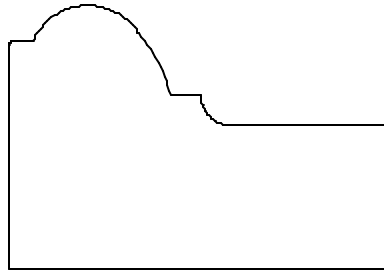

OB1302 1-3/8 X 2

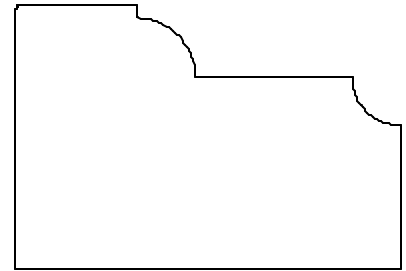

OB1303 1-3/8 X 2

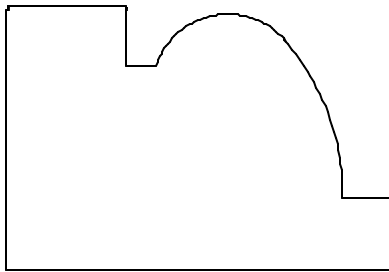

OB1304 1-3/8 X 2

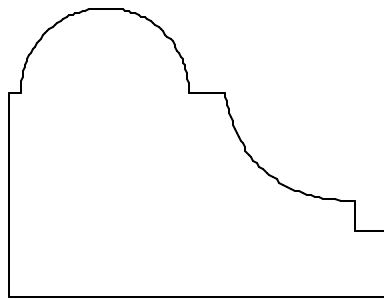

OB1305 1-1/2 X 2

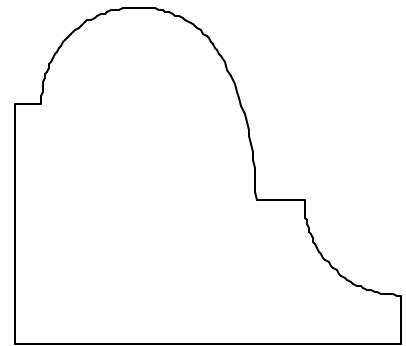

OB1306 1-3/4 X 2

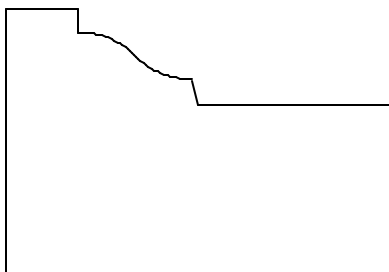

OB1307 1-3/8 X 2

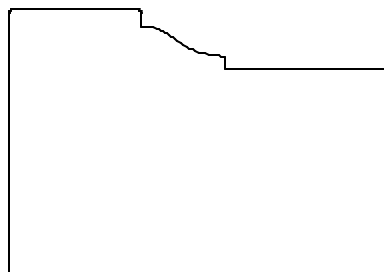

OB1308 1-3/8 X 2

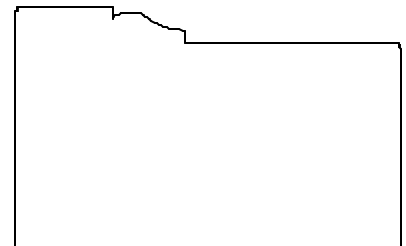

OB1309 1-1/4 X 2

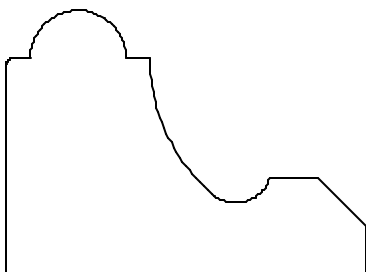

OB1310 1-3/8 X 1-7/8

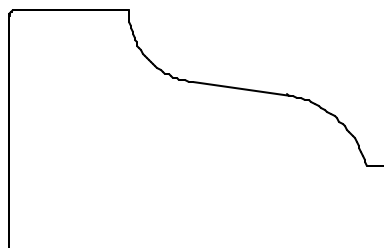

OB1311 1-1/4 X 2

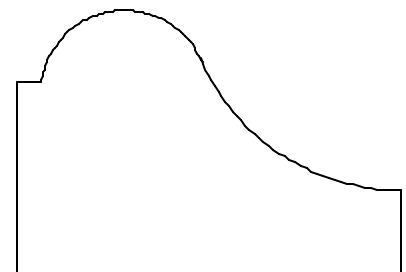

OB1312 1-3/8 X 2

ALL MOULDINGS ARE MADE TO ORDER AND ARE AVAILABLE IN ANY SPECIES OF WOOD.

O.B. WILLIAMS COMPANY

ESTABLISHED 1889

1939 FIRST AVE. SO. SEATTLE, WASHINGTON 98134 (206) 623-2494 FAX 623-2602

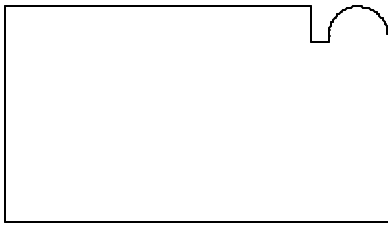

OB1313 1-1/8 X 2

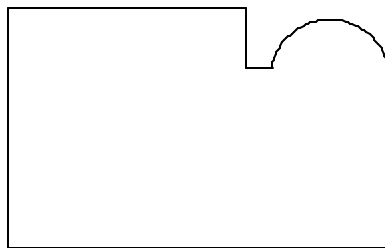

OB1314 1-1/4 X 2

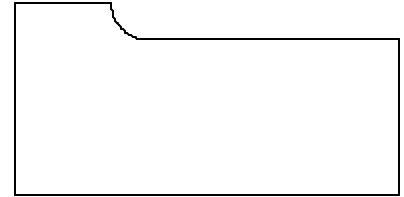

OB1315 1 X 2

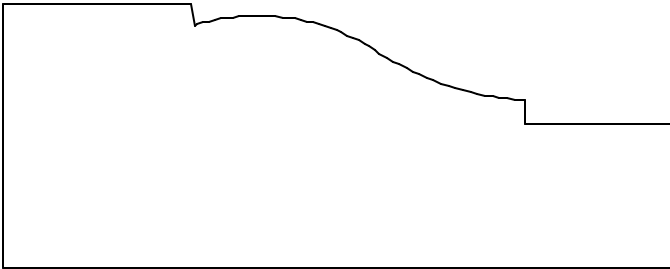

OB1316 1-3/8 X 3-1/2

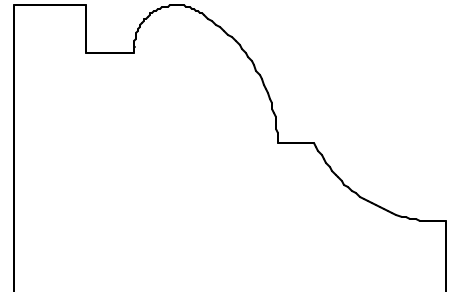

OB1317 1-1/2 X 2-1/4

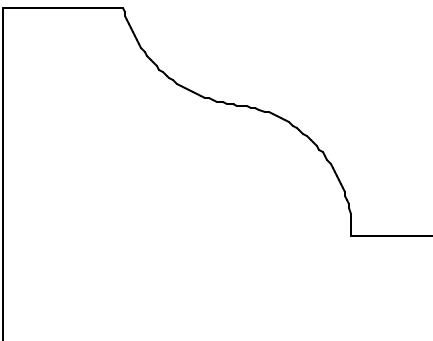

OB1318 1-3/4 X 2-1/4

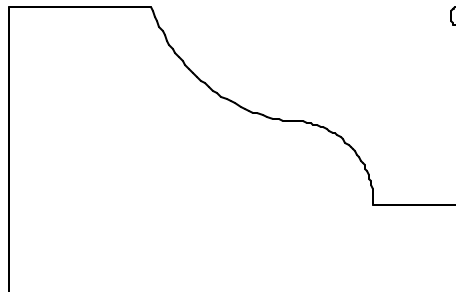

OB1319 1-1/2 X 2-3/8

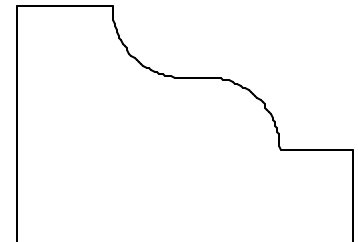

OB1320 1-1/4 X 1-3/4



OB1321 1-1/2 X 2

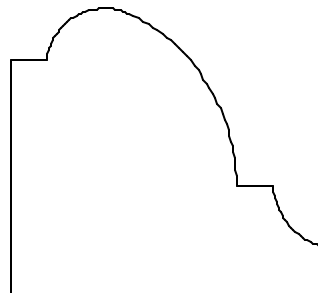

OB1322 1-1/2 X 1-5/8

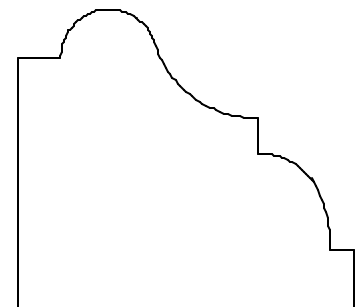

OB1323 1-1/2 X 1-3/4

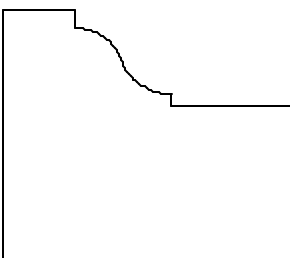

OB1324 1-5/16 X 1-1/2

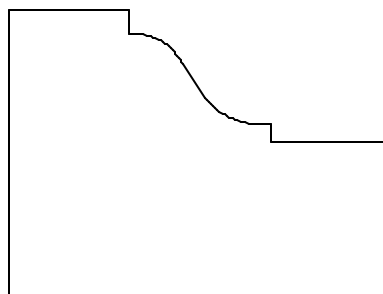

OB1325 1-1/2 X 2

ASTRAGALS

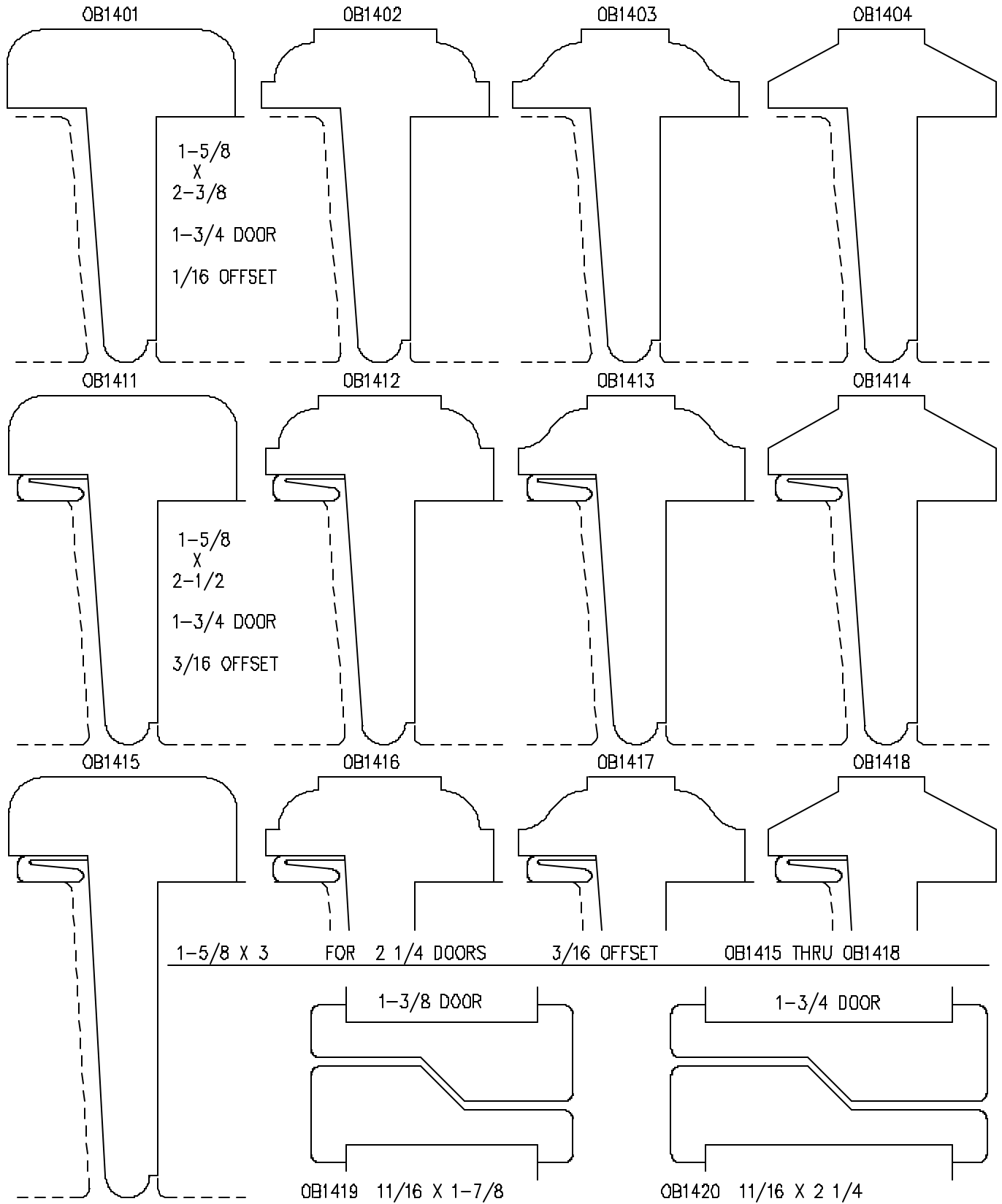

ALL MOULDINGS ARE MADE TO ORDER AND ARE AVAILABLE IN ANY SPECIES OF WOOD.

TONGUE AND GROOVE

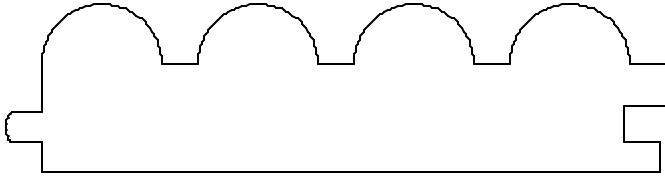

OB1501 7/8 X 3-7/16

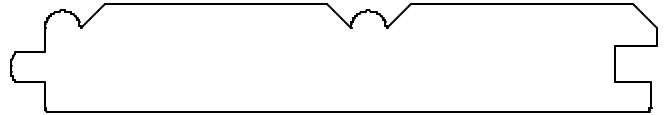

OB1507 9/16 X 3-3/8

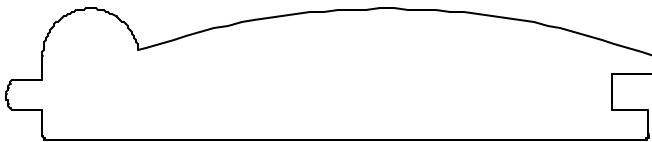

OB1502 11/16 X 3-3/8



OB1508 9/16 X 3-3/8

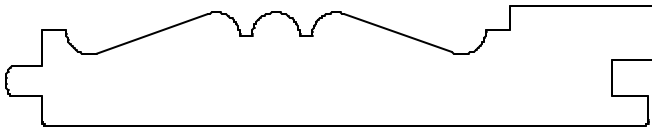

OB1503 5/8 X 3-3/8



OB1509 9/16 X 3-3/8

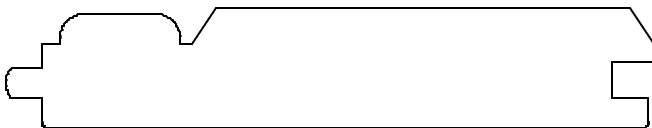

OB1504 5/8 X 3-3/8

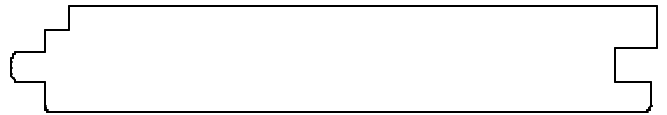

OB1510 9/16 X 3-3/8



OB1505 5/8 X 3-3/8

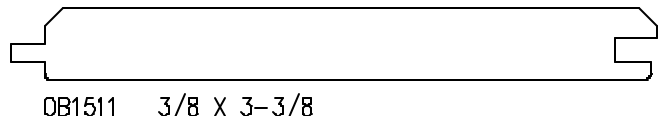

OB1511 3/8 X 3-3/8



OB1506 9/16 X 3-3/8

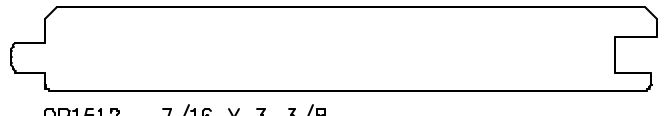

OB1512 7/16 X 3-3/8



OB1513 9/16 X 3-3/8

ALL MOULDINGS ARE MADE TO ORDER AND ARE AVAILABLE IN ANY SPECIES OF WOOD.

O.B. WILLIAMS COMPANY

ESTABLISHED 1889

1939 FIRST AVE. SO. SEATTLE, WASHINGTON 98134 (206) 623-2494 FAX 623-2602

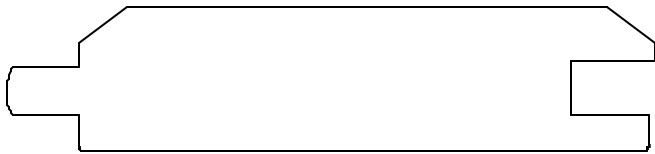

OB1514 3/4 X 3-3/8



OB1518 3/4 X 3-3/8



OB1515 3/4 X 3-3/8



OB1519 3/4 X 3-3/8



OB1516 1/2 X 3-3/8

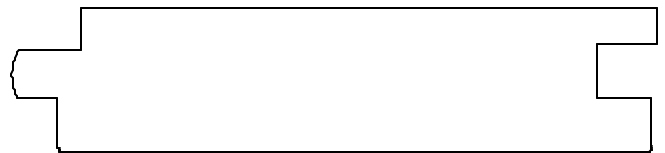

OB1520 3/4 X 3-3/8



OB1517 3/4 X 3-3/8

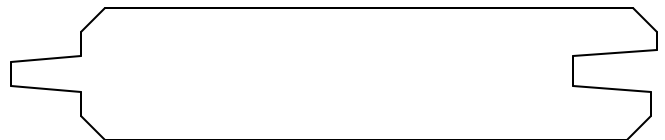

OB1521 11/16 X 3-3/8



OB1522 3/4 X 5-1/2



OB1523 3/4 X 5-1/2



OB1524 3/4 X 7-1/4

ALL MOULDINGS ARE MADE TO ORDER AND ARE AVAILABLE IN ANY SPECIES OF WOOD.

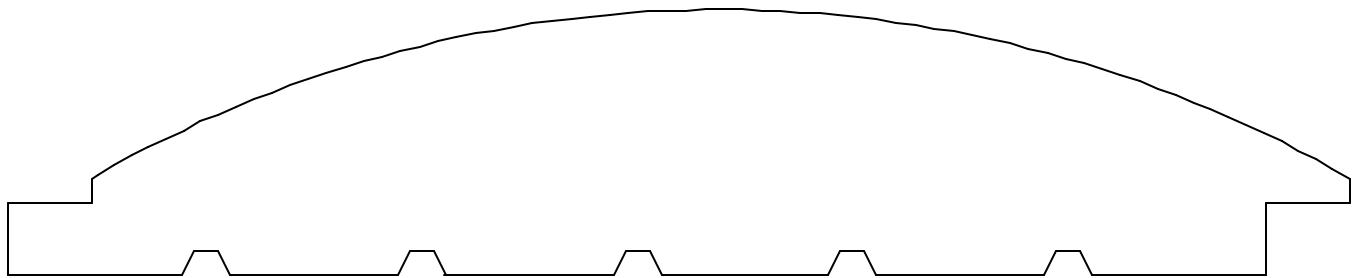

OB1525 1-3/8 X 7

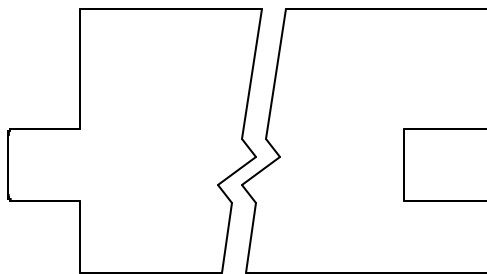

OB1526	1-3/8 X 2"	FACE	2-3/8 OA
OB1527	" 3"	"	3-3/8 OA
OB1528	" 4"	"	4-3/8 OA
OB1529	" 5"	"	5-3/8 OA
OB1530	" 7"	"	7-3/8 OA

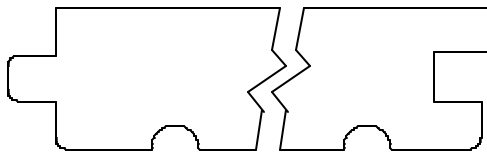

OB1531	3/4 X 2-1/4"	FACE	2-1/2 OA
OB1532	" 3-1/8"	"	3-3/8 OA
OB1533	" 4-1/8"	"	4-3/8 OA
OB1534	" 5-1/8"	"	5-3/8 OA
OB1535	" 6"	"	6-1/4 OA
OB1536	" 7"	"	7-1/4 OA
OB1537	" 9"	"	9-1/4 OA

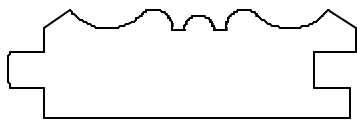

OB1538 9/16 X 1-13/16

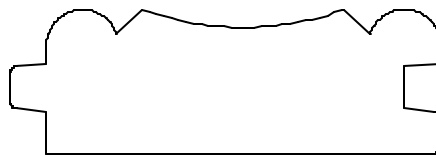

OB1539 3/4 X 2-1/4

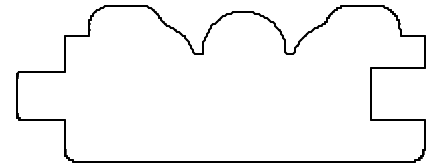

OB1540 13/16 X 2-1/8

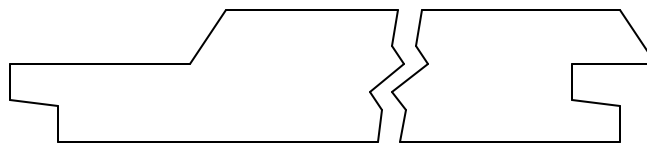

OB1541 11/16 X 3 3/8
OB1542 11/16 X 5 1/8

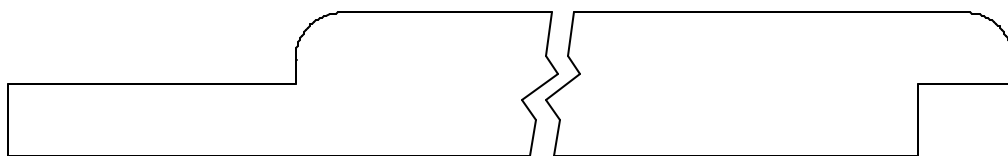

OB1543 3/4 X 5 1/4
OB1544 3/4 X 7 1/4

ALL MOULDINGS ARE MADE TO ORDER AND ARE AVAILABLE IN ANY SPECIES OF WOOD.

CHAIR RAILS



OB1601
3/4 X 2-3/4

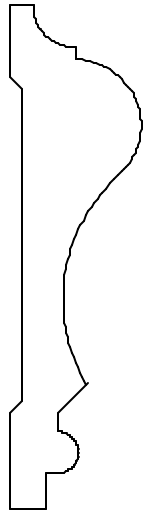

OB1602
11/16 X 2-5/8

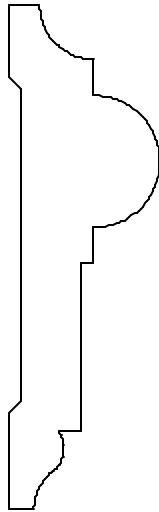

OB1603
3/4 X 2-5/8



OB1604
11/16 X 2-1/2

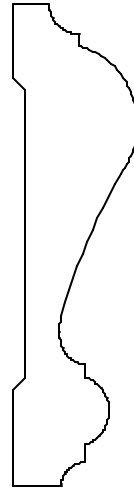

OB1605
5/8 X 2-1/2

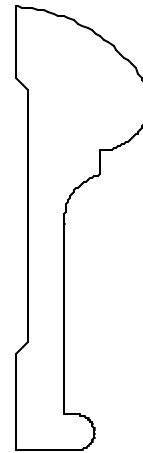

OB1606
11/16 X 2-5/16

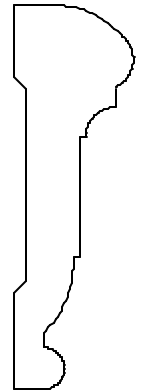

OB1607
5/8 X 2

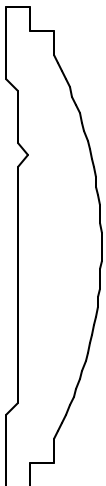

OB1608
1/2 X 2-1/2

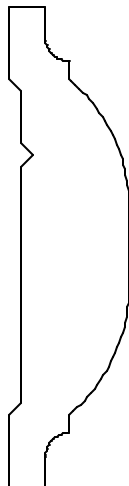

OB1609
5/8 X 2-1/2



OB1610
3/4 X 2-1/2



OB1611
13/16 X 2-1/2

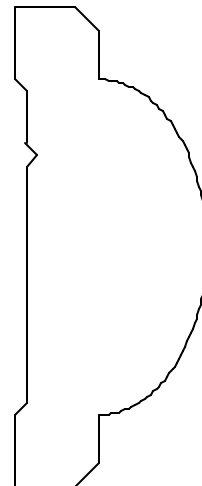

OB1612
1 X 2-1/2

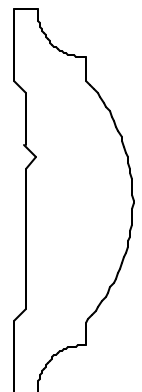

OB1613
5/8 X 2

MOST OF THE ABOVE MOULDINGS CAN BE MADE THICKER THAN SHOWN
ALL MOULDINGS ARE MADE TO ORDER AND ARE AVAILABLE IN ANY SPECIES OF WOOD.

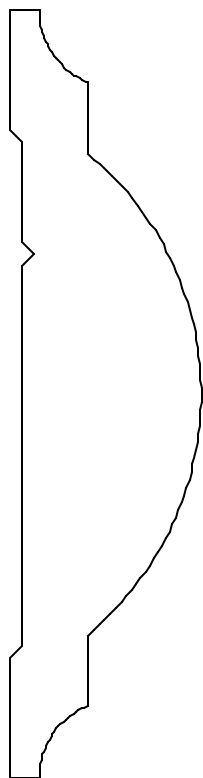

OB1614
1 X 4

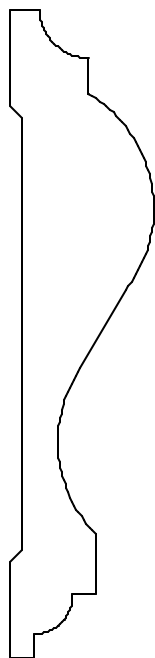

OB1615
3/4 X 3-3/8

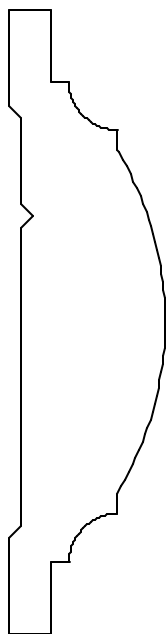

OB1616
13/16 X 3-1/4

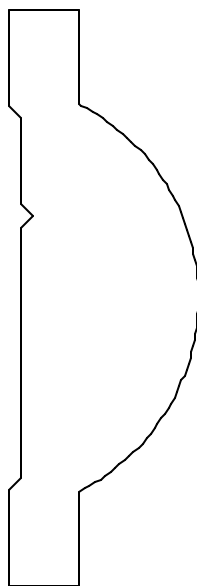

OB1617
1 X 3

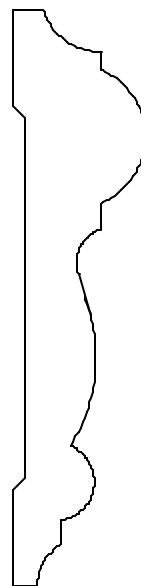

OB1618
11/16 X 3

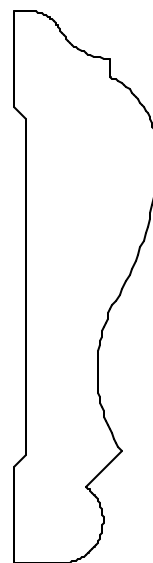

OB1619
3/4 X 2-7/8

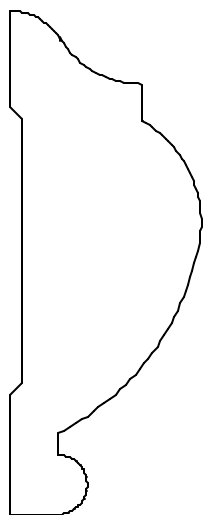

OB1620
1 X 2-5/8

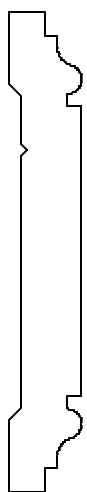

OB1621
3/8 X 2-1/2

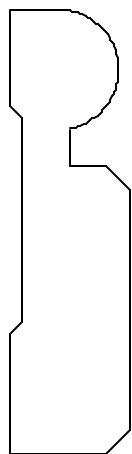

OB1622
5/8 X 2-5/16

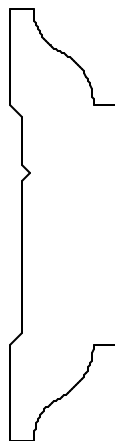

OB1623
9/16 X 2-1/4



OB1624
1/2 X 2-1/4



OB1625
1/2 X 2-1/4



OB1626
5/8 X 1-7/8

MOST OF THE ABOVE MOULDINGS CAN BE MADE THICKER THAN SHOWN
ALL MOULDINGS ARE MADE TO ORDER AND ARE AVAILABLE IN ANY SPECIES OF WOOD.

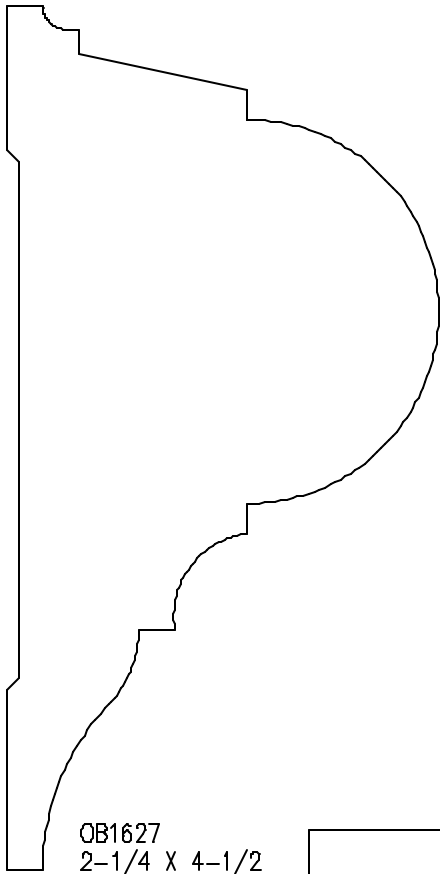

OB1627
2-1/4 X 4-1/2

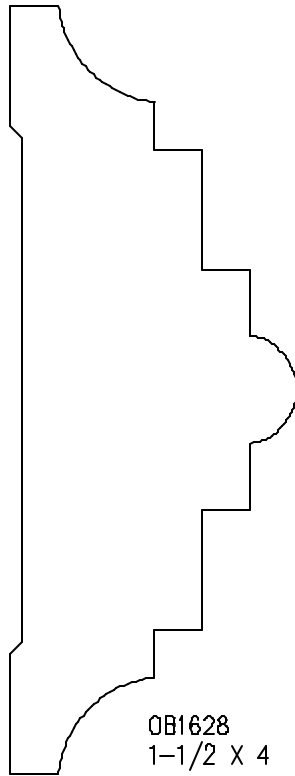

OB1628
1-1/2 X 4

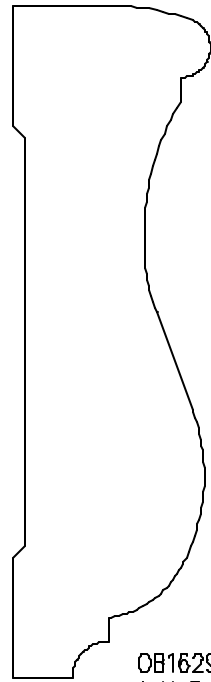

OB1629
1 X 3-1/2

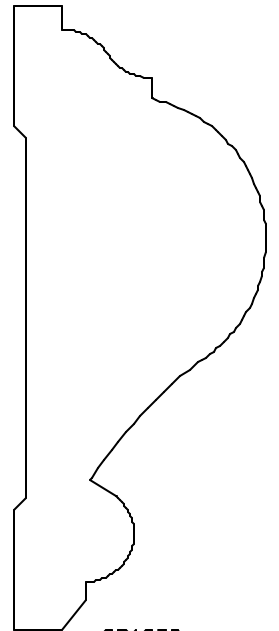

OB1630
1-5/16 X 3-1/4

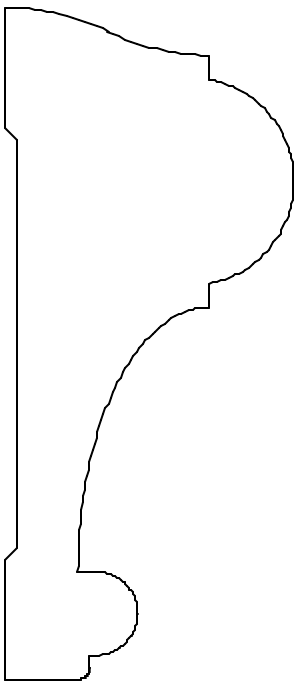

OB1631
1-1/2 X 3-1/2

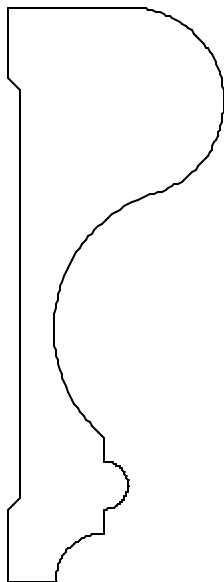

OB1632
1-1/8 X 3

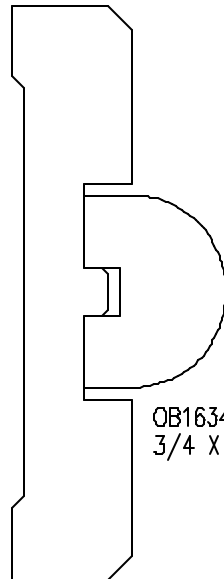

OB1633
5/8 X 3

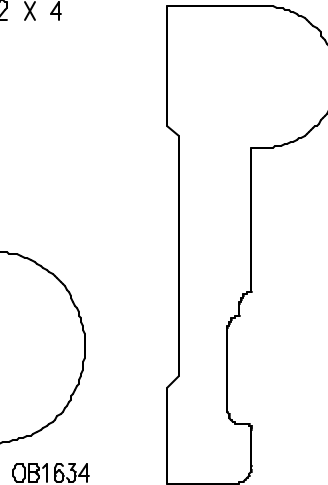

OB1634
3/4 X 1

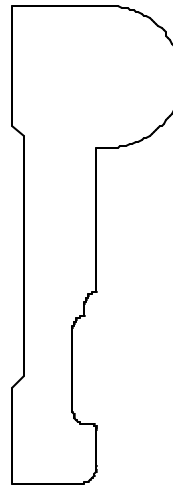

OB1635
7/8 X 2-1/2

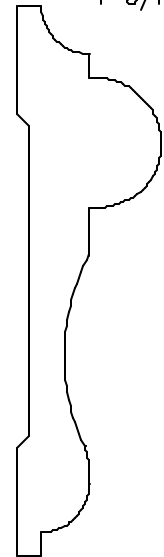

OB1636
3/4 X 2-7/8

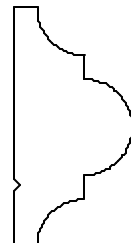

OB1637
5/8 X 1-1/4

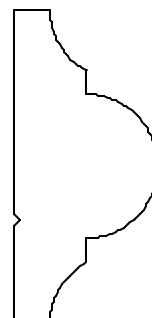

OB1638
3/4 X 1-5/8

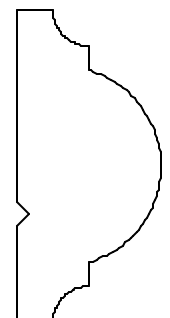

OB1639
3/4 X 1-5/8

ROUNDS

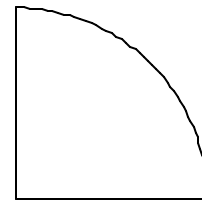
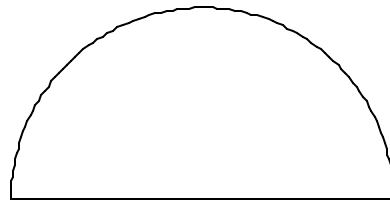
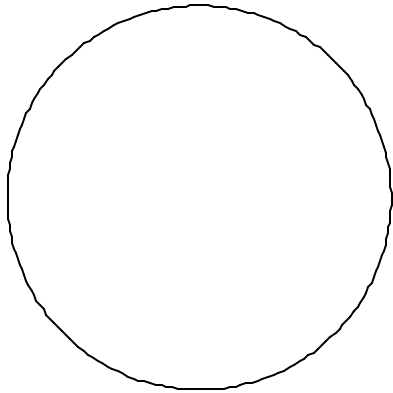

- OB1701 1/2 X 1/2
- OB1702 5/8 X 5/8
- OB1713 3/4 X 3/4
- OB1714 7/8 X 7/8
- OB1715 1 X 1
- OB1702 1-1/8 X 1-1/8
- OB1716 1-1/4 X 1-1/4
- OB1703 1-5/16 X 1-5/16
- OB1717 1-3/8 X 1-3/8
- OB1704 1-1/2 X 1-1/2
- OB1718 1-9/16 X 1-9/16
- OB1705 1-3/4 X 1-3/4
- OB1719 1-7/8 X 1-7/8
- OB1706 2 X 2
- OB1720 2-1/2 X 2-1/2
- OB1721 2-5/8 X 2-5/8
- OB1707 2-3/4 X 2-3/4
- OB1708 3 X 3
- OB1709 3-1/2 X 3-1/2
- OB1722 3-3/4 X 3-3/4
- OB1710 4 X 4
- OB1723 4-1/2 X 4-1/2
- OB1711 5 X 5

- OB1817 1/8 X 1/4
- OB1818 5/32 X 5/16
- OB1801 3/16 X 3/8
- OB1819 7/32 X 7/16
- OB1802 1/4 X 1/2
- OB1803 3/8 X 3/4
- OB1804 13/32 X 13/16
- OB1805 1/2 X 1
- OB1822 17/32 X 1-1/16
- OB1820 9/16 X 1-1/8
- OB1806 5/8 X 1-1/4
- OB1821 23/32 X 1-7/16
- OB1807 3/4 X 1 1/2
- OB1808 7/8 X 1-3/4
- OB1809 1 X 2
- OB1823 1-1/8 X 2-1/4
- OB1810 1-1/4 X 2-1/2
- OB1811 1-3/8 X 2-3/4
- OB1812 1-1/2 X 3
- OB1824 1-5/8 X 3-1/4
- OB1813 1-3/4 X 3-1/2
- OB1825 1-7/8 X 3-3/4
- OB1814 2 X 4
- OB1815 2-1/2 X 5
- OB1816 3 X 6

- OB1901 3/8 X 3/8
- OB1902 1/2 X 1/2
- OB1903 5/8 X 5/8
- OB1904 3/4 X 3/4
- OB1905 7/8 X 7/8
- OB1906 1 X 1
- OB1916 1-3/16 X 1-3/16
- OB1907 1-1/4 X 1-1/4
- OB1908 1-3/8 X 1-3/8
- OB1909 1-1/2 X 1-1/2
- OB1910 1-3/4 X 1-3/4
- OB1917 1-7/8 X 1-7/8
- OB1911 2 X 2
- OB1912 2-3/8 X 2-3/8
- OB1913 2-1/2 X 2-1/2
- OB1914 2-3/4 X 2-3/4
- OB1915 3 X 3

DRIP CAPS

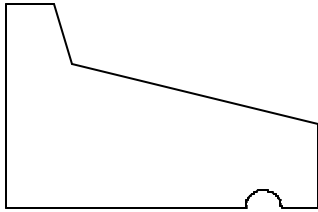

OB2001 1-1/16 X 1-5/8

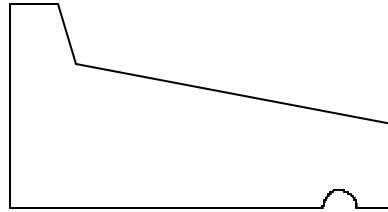

OB2002 1-1/16 X 2

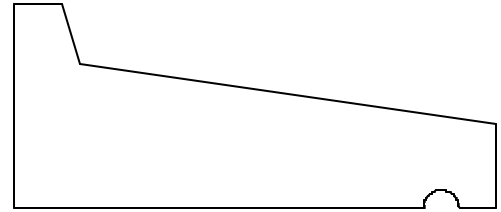

OB2003 1-1/16 X 2-1/2

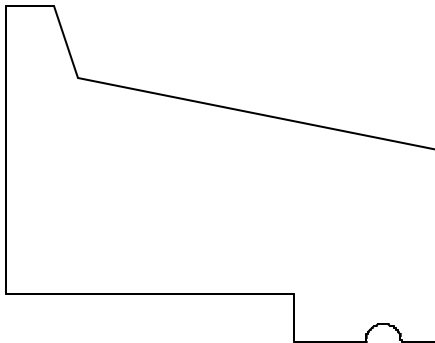

OB2004 1-3/4 X 2-1/4

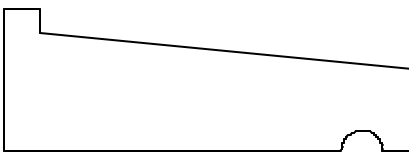

OB2005 3/4 X 2-1/8

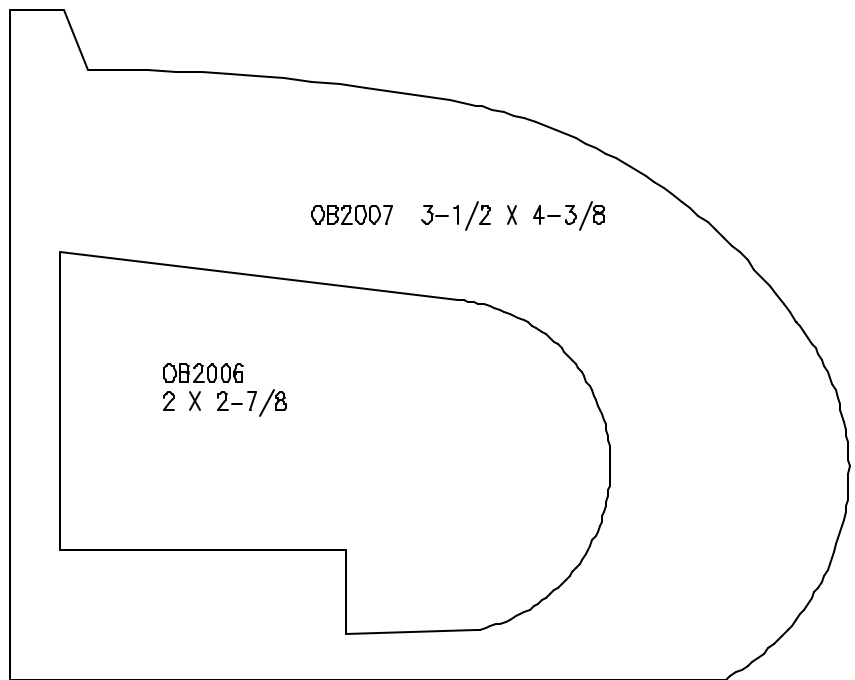

OB2006
2 X 2-7/8

OB2007 3-1/2 X 4-3/8

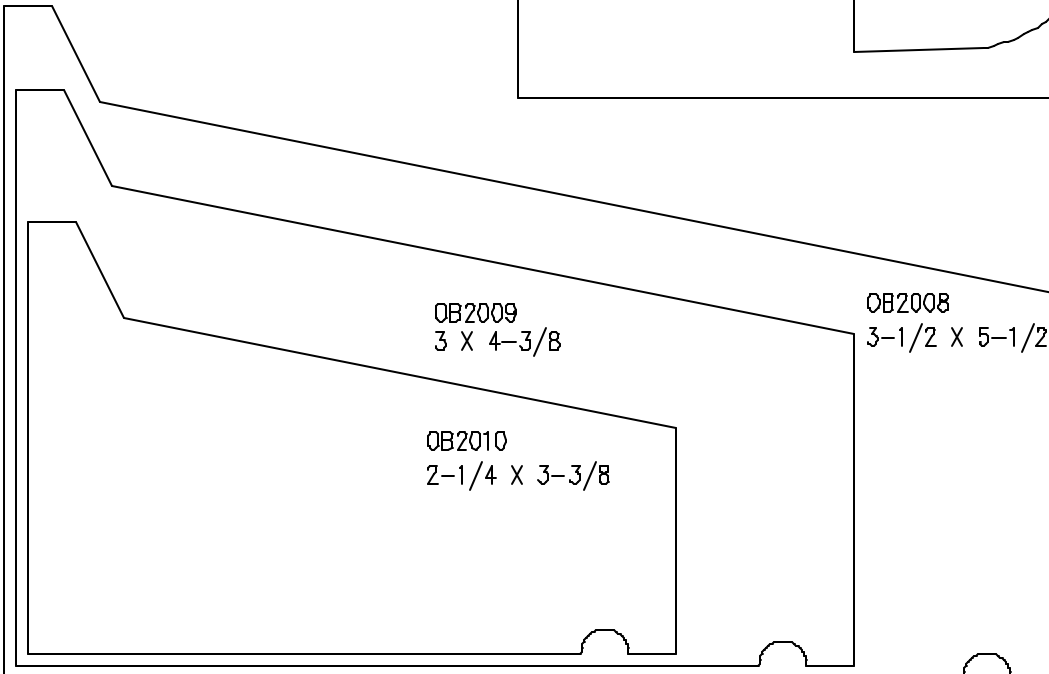

OB2009
3 X 4-3/8

OB2008
3-1/2 X 5-1/2

OB2010
2-1/4 X 3-3/8

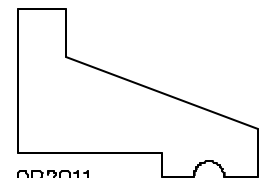

OB2011
7/8 X 1-1/4

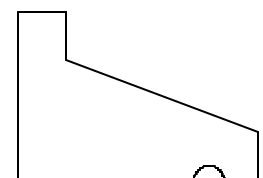

OB2012
7/8 X 1-1/4

COVES

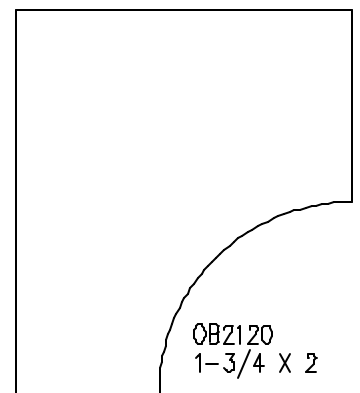
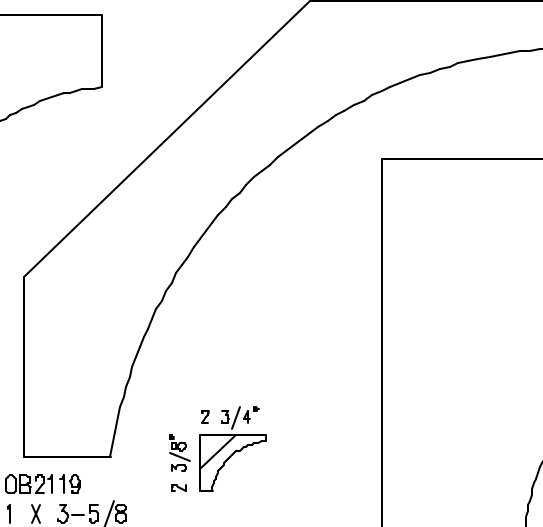
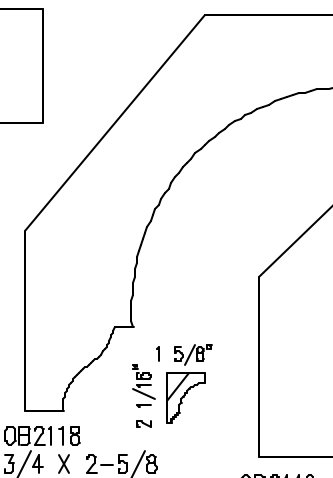
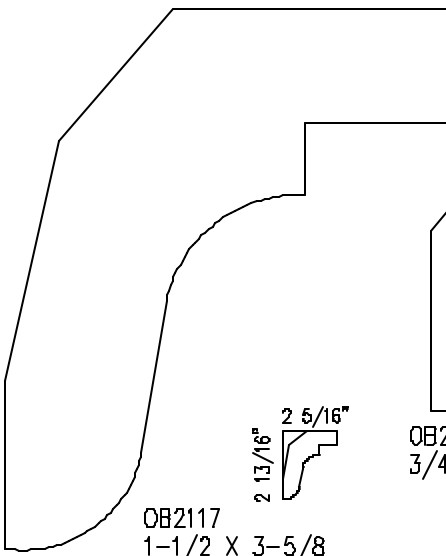
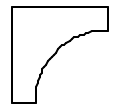
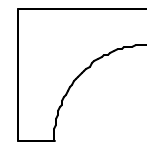
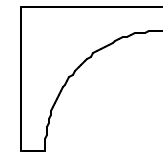
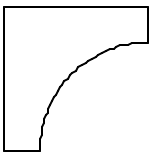
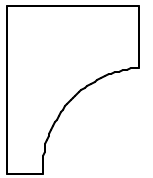
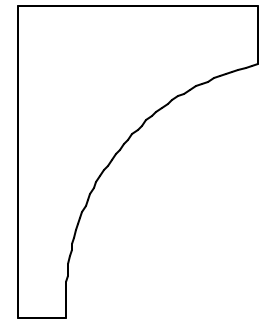
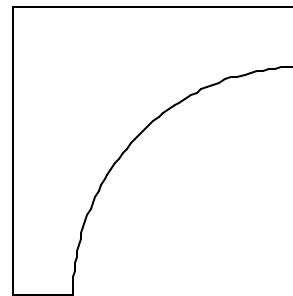
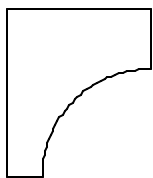
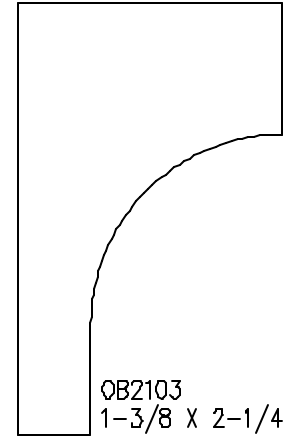
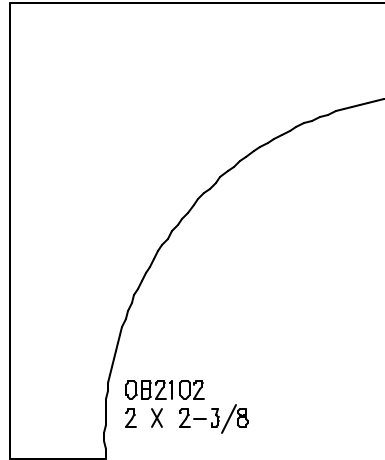
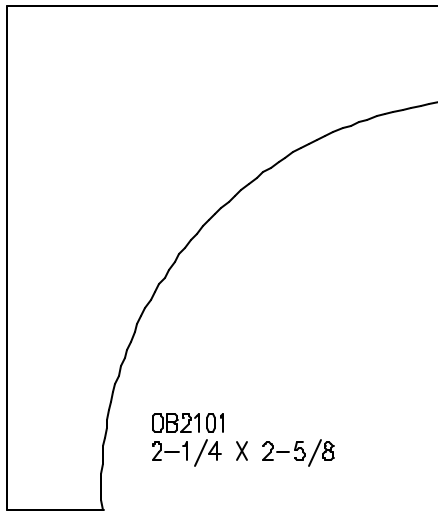

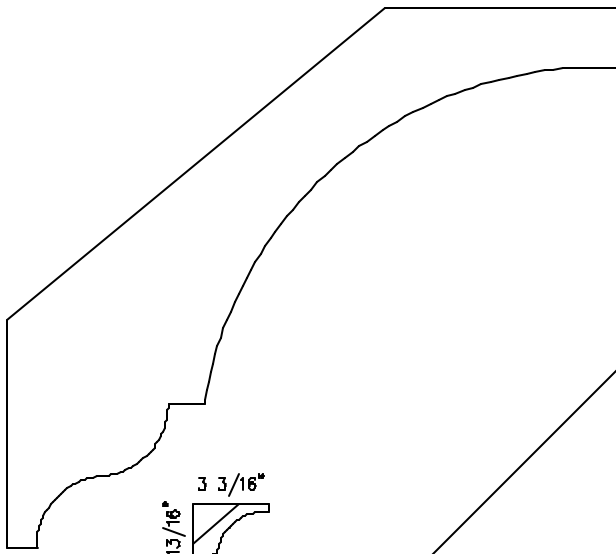

OB2121
1 X 4-1/4

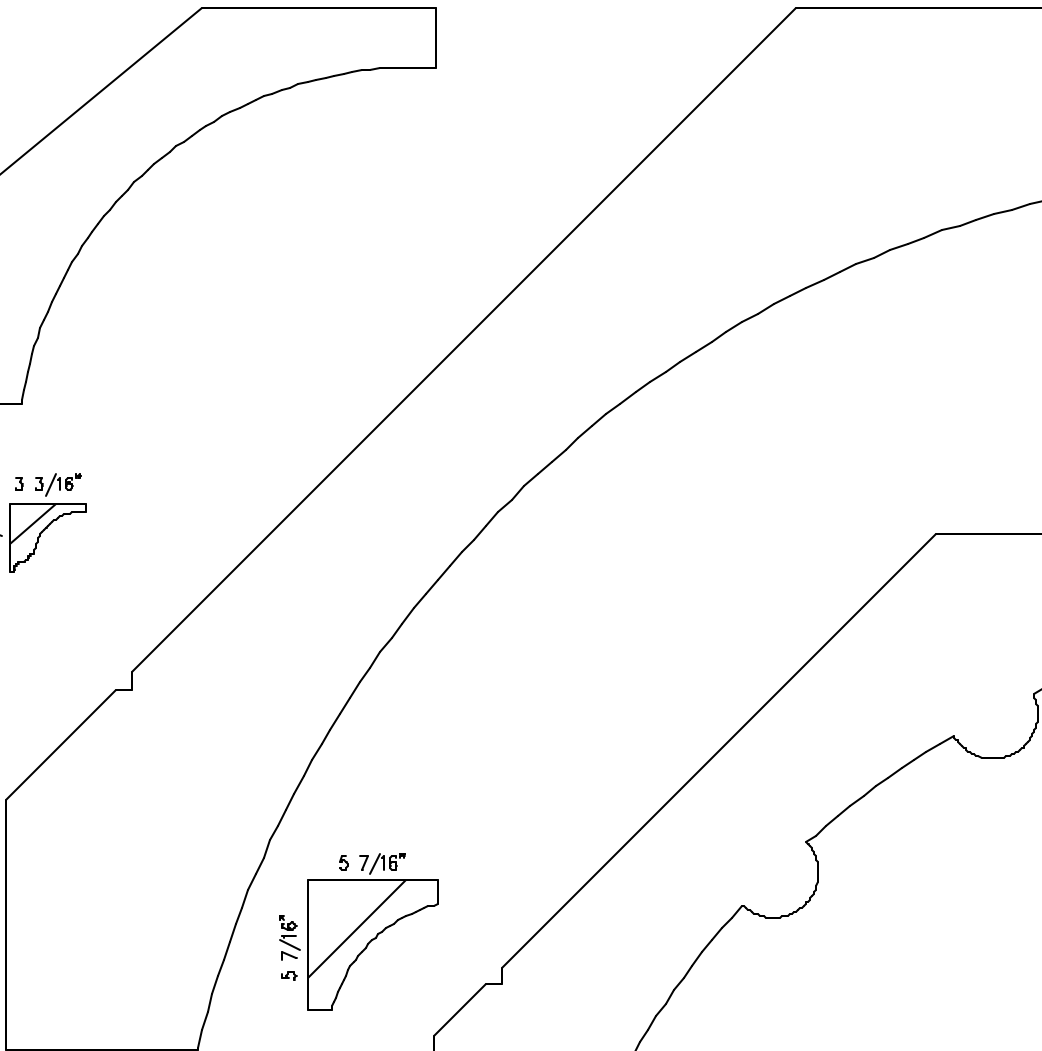

OB2123
1-5/8 X 7-5/8

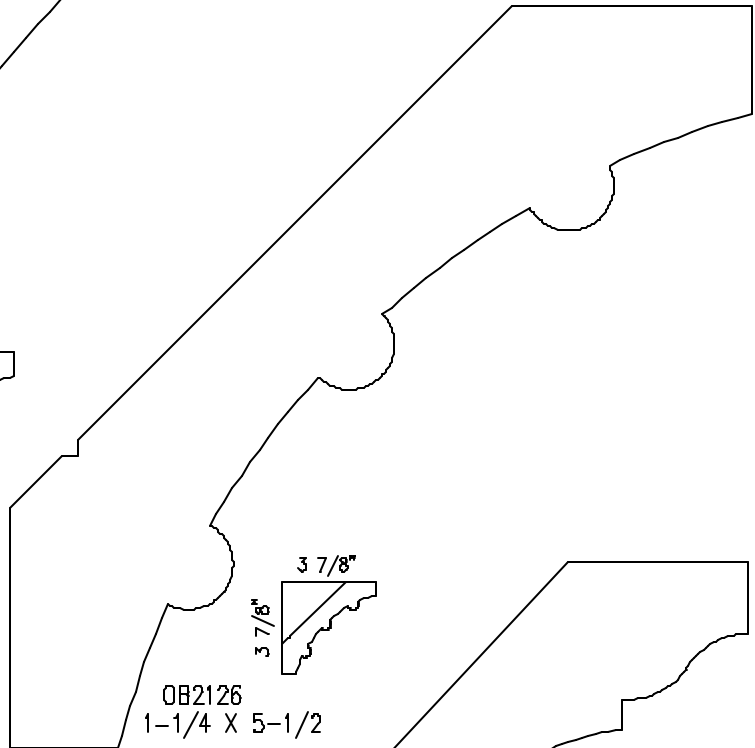

OB2126
1-1/4 X 5-1/2

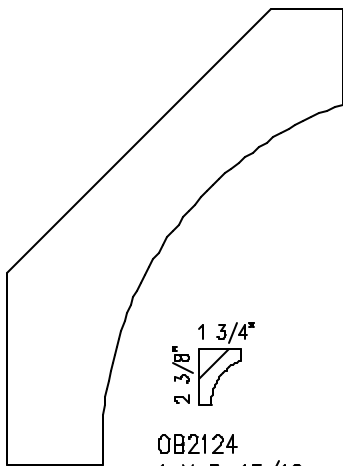

OB2124
1 X 2-15/16

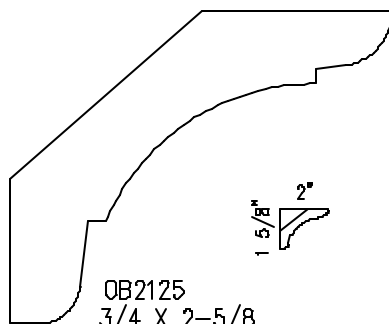

OB2125
3/4 X 2-5/8

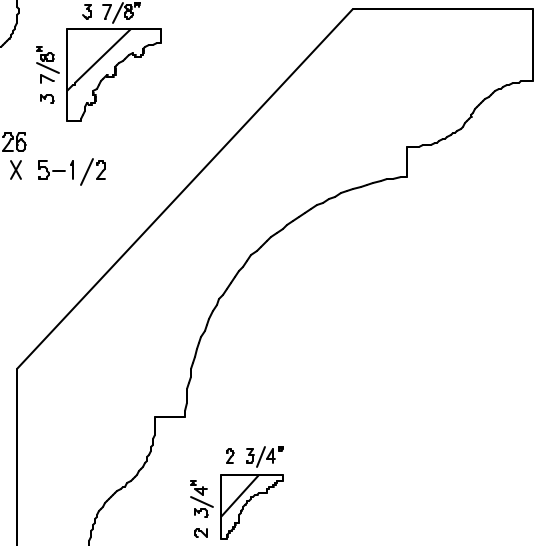

OB2127
1 X 3-7/8

ALL MOULDINGS ARE MADE TO ORDER AND ARE AVAILABLE IN ANY SPECIES OF WOOD.

O.B. WILLIAMS COMPANY

ESTABLISHED 1889

1939 FIRST AVE. SO. SEATTLE, WASHINGTON 98134 (206) 623-2494 FAX 623-2602

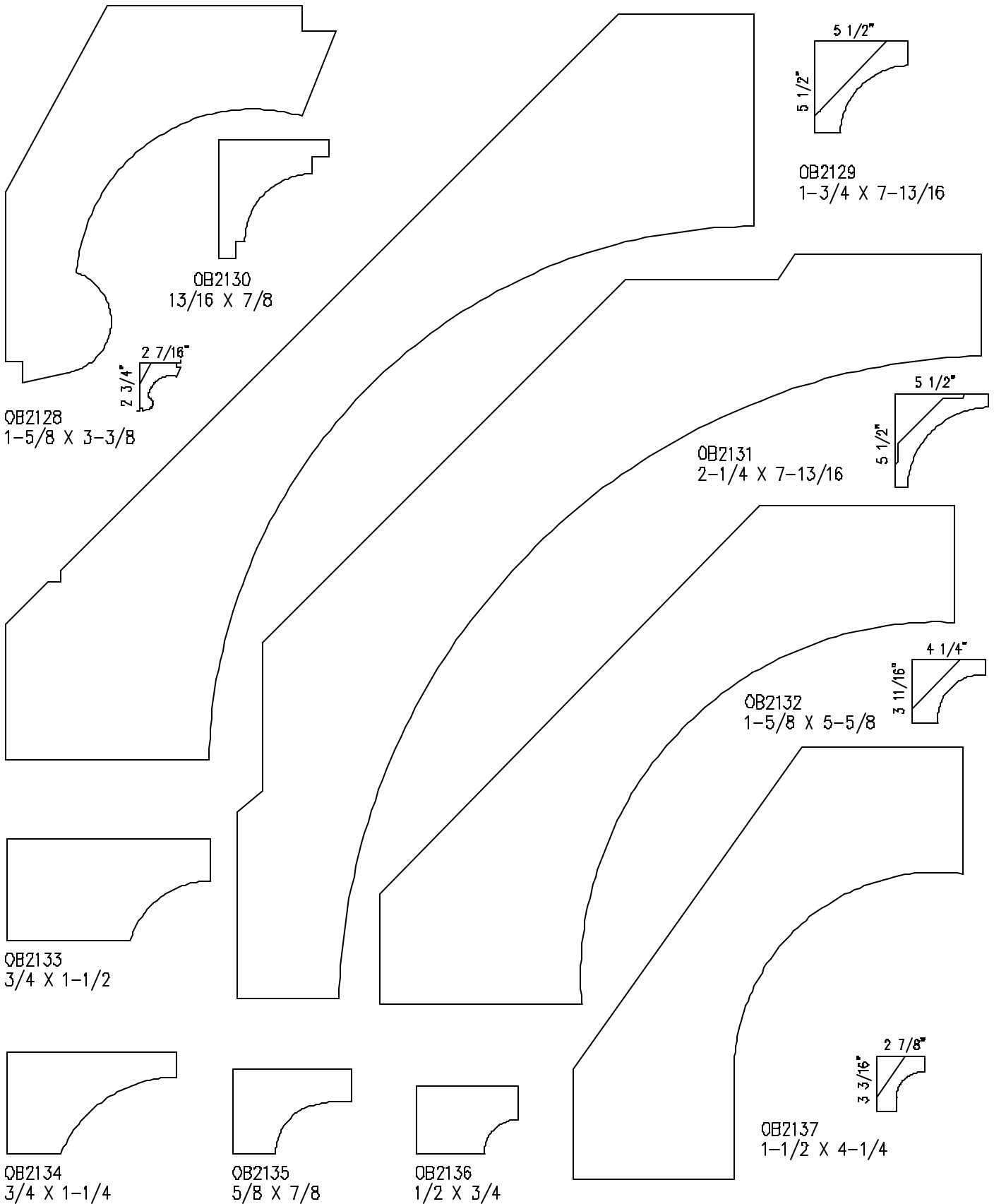

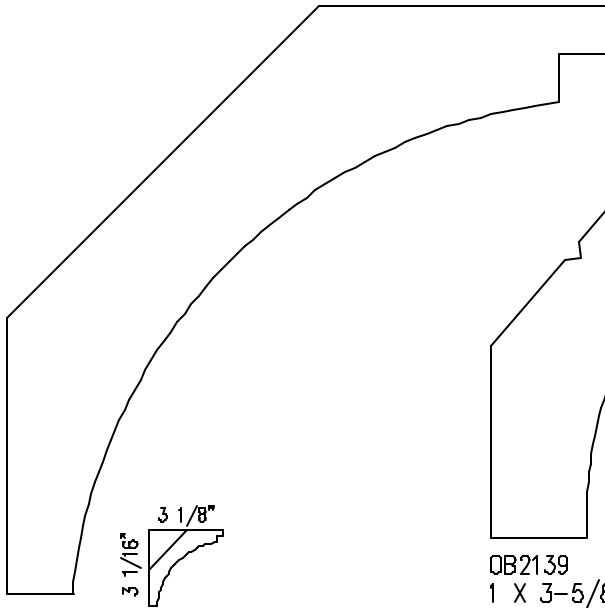

OB2138
1-1/4 X 4-3/8

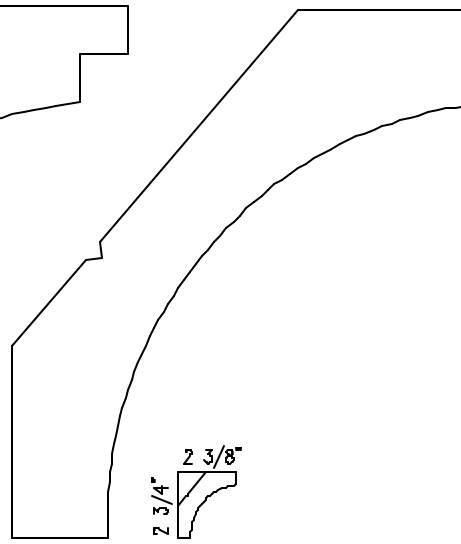

OB2139
1 X 3-5/8

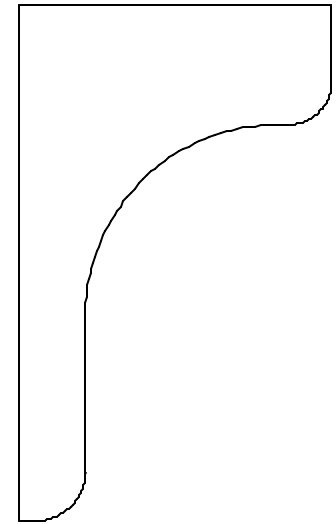

OB2140
1-5/8 X 2-5/8

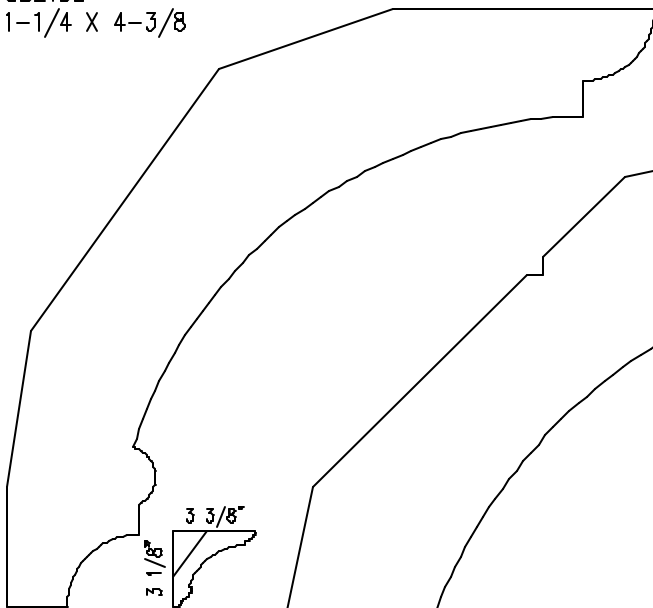

OB2141
1-3/4 X 4-1/2

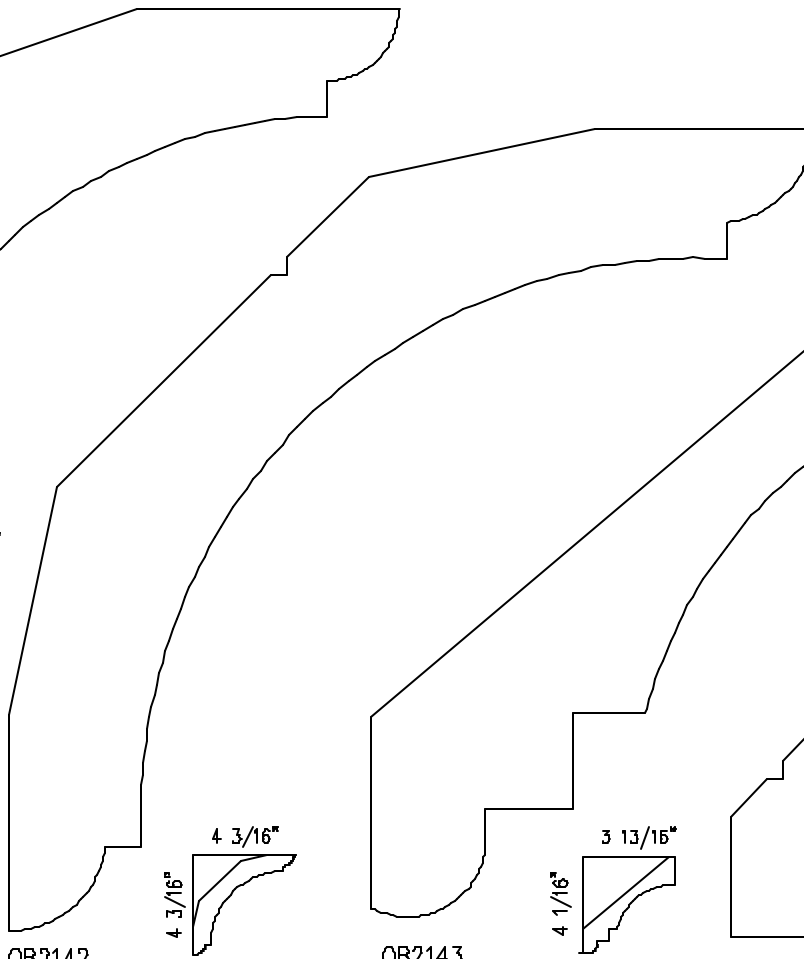

OB2142
1-5/8 X 5-7/8

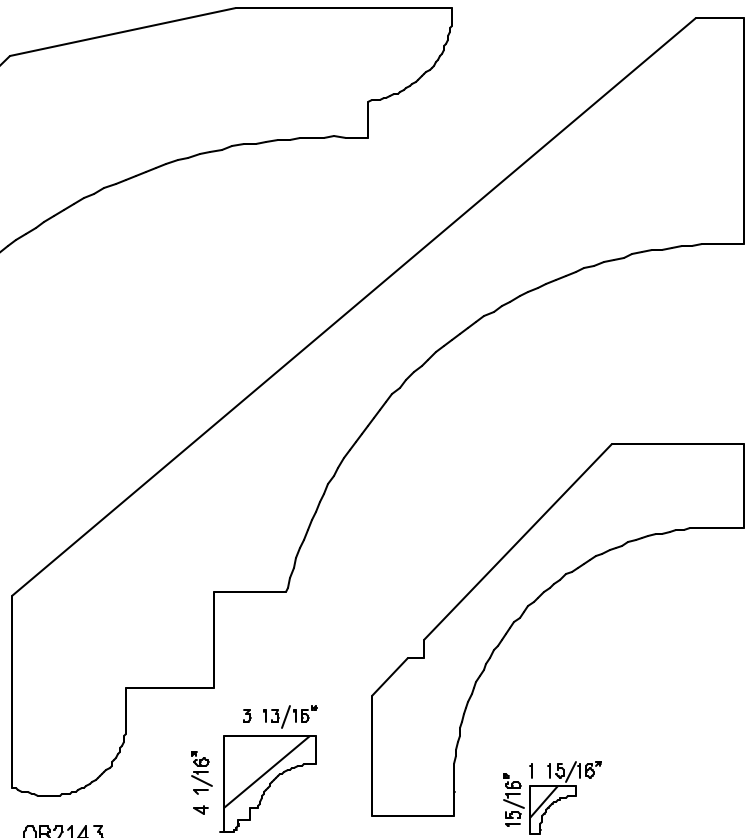

OB2143
1 X 5-1/2

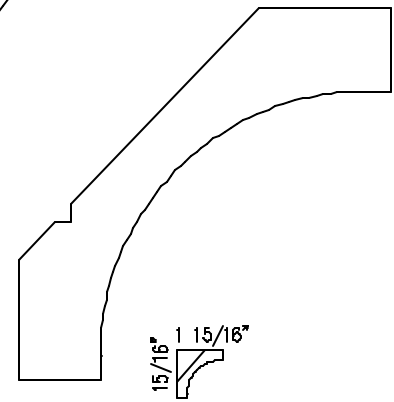

OB2144
3/4 X 2-5/8

ALL MOULDINGS ARE MADE TO ORDER AND ARE AVAILABLE IN ANY SPECIES OF WOOD.

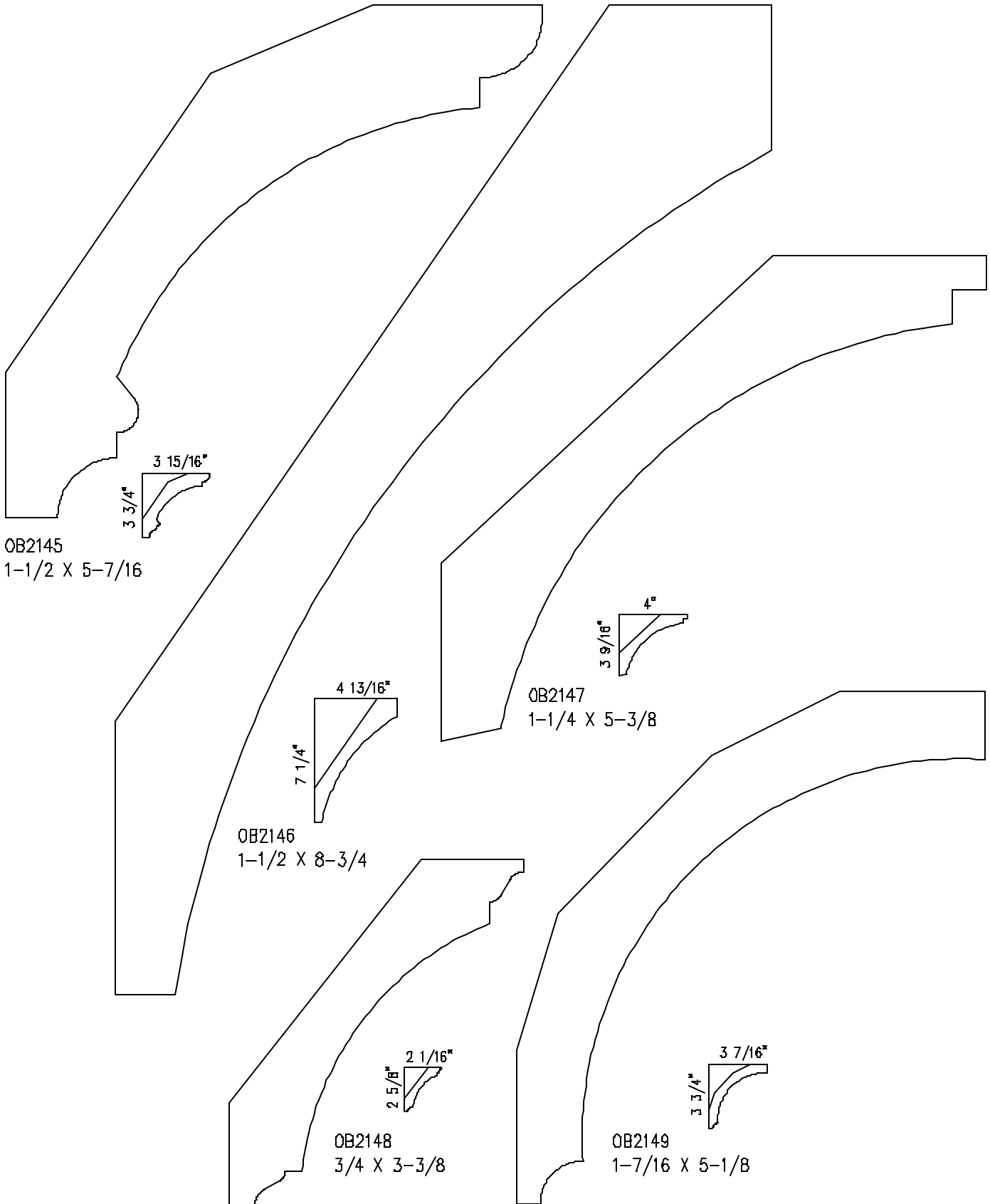

ALL MOULDINGS ARE MADE TO ORDER AND ARE AVAILABLE IN ANY SPECIES OF WOOD.

SCREEN MOULDINGS



OB2201
1/4 X 3/4



OB2202
5/16 X 3/4



OB2203
1/4 X 3/4



OB2204
1/4 X 3/4



OB2205
1/4 X 3/4

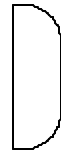

OB2206
1/4 X 3/4



OB2207
3/8 X 3/4



OB2208
3/8 X 5/8



OB2209
1/4 X 5/8

LINTEL CAPS

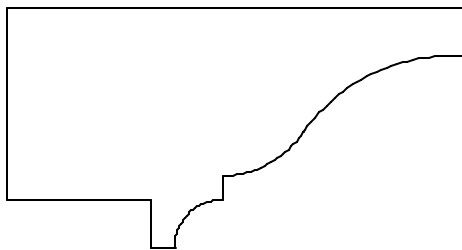

OB2301 1-1/4 X 2-3/8

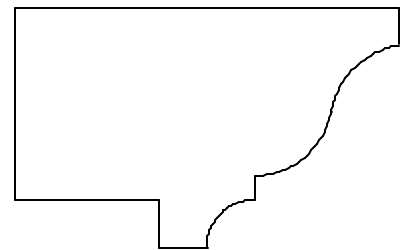

OB2302 1-1/4 X 2

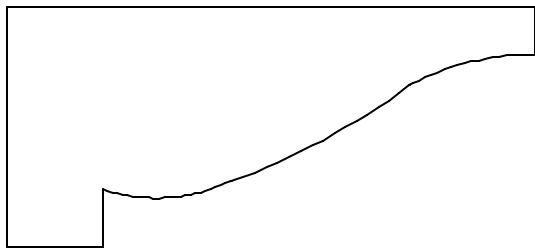

OB2303 1-1/4 X 2-3/4

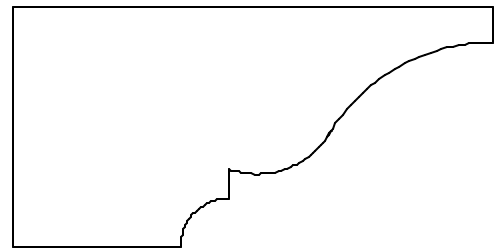

OB2304 1-1/4 X 2-1/2

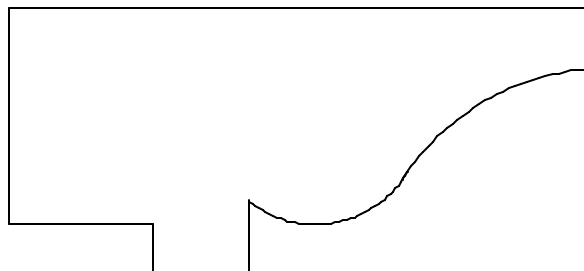

OB2305 1-3/8 X 3

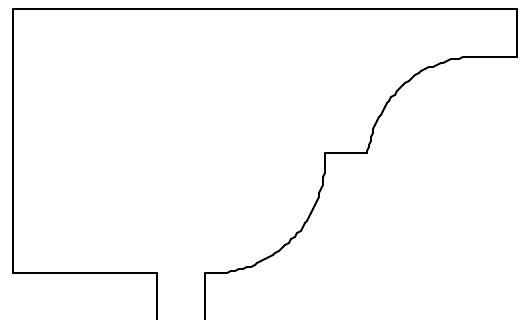

OB2306 1-5/8 X 2-5/8

ALL MOULDINGS ARE MADE TO ORDER AND ARE AVAILABLE IN ANY SPECIES OF WOOD.

O.B. WILLIAMS COMPANY

ESTABLISHED 1889

1939 FIRST AVE. SO. SEATTLE, WASHINGTON 98134 (206) 623-2494 FAX 623-2602

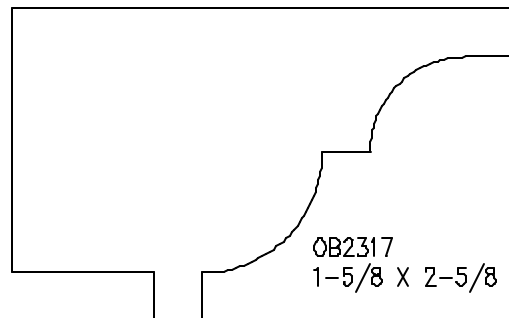
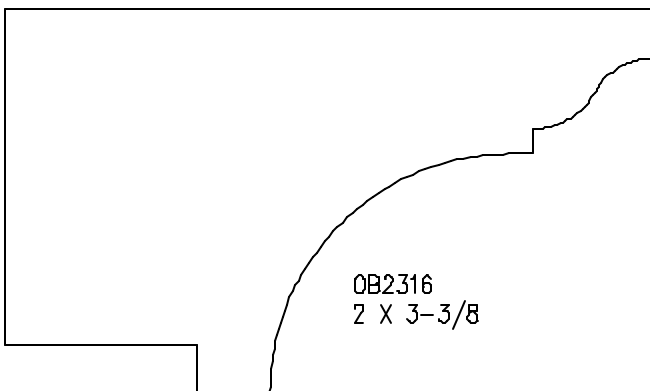
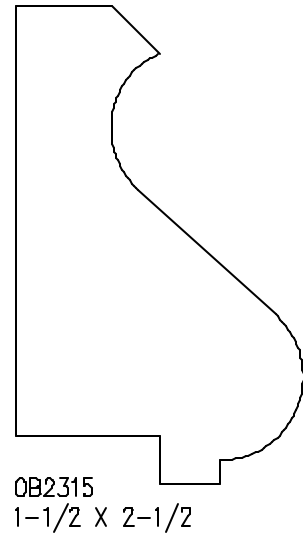
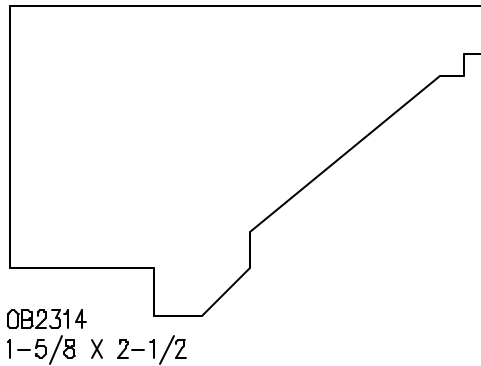
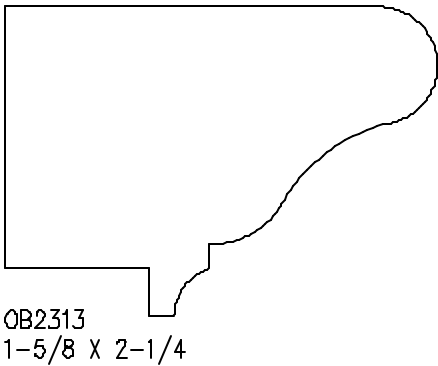
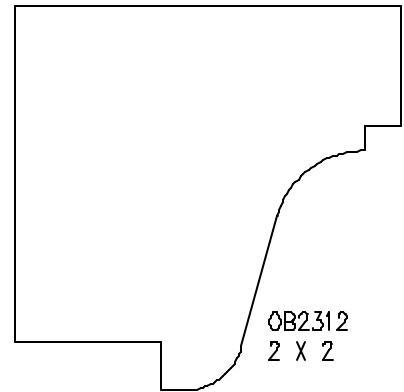
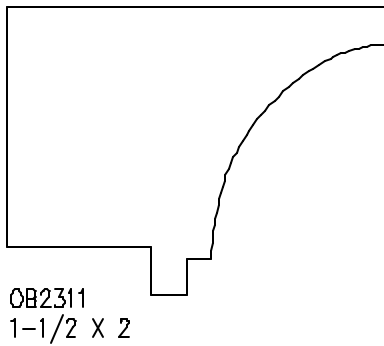
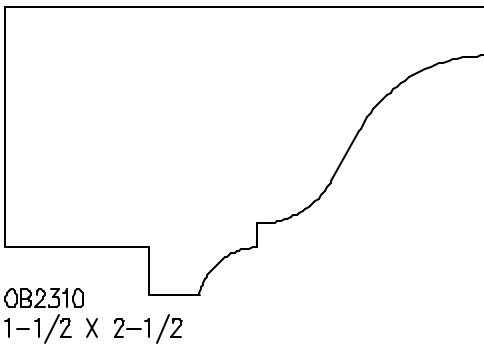
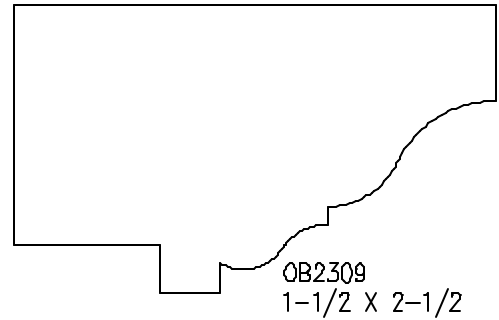
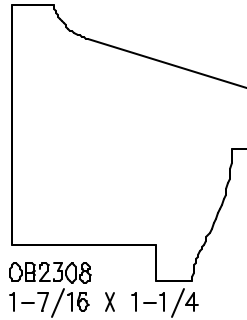
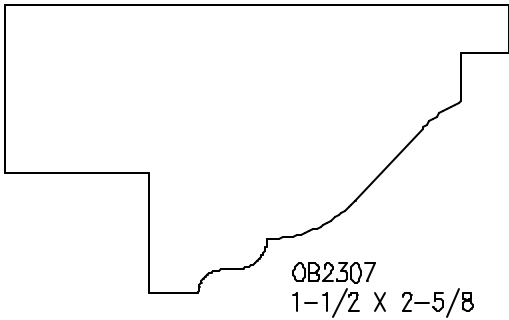

SHOES

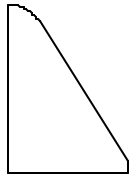

OB2401
5/8 X 7/8

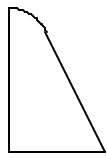

OB2402
1/2 X 3/4

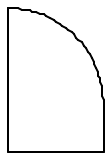

OB2403
1/2 X 3/4



OB2404
7/16 X 11/16



OB2405
1/2 X 3/4



OB2406
3/8 X 7/8



OB2407
3/8 X 7/8

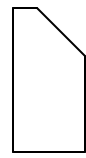

OB2408
3/8 X 3/4



OB2409
3/8 X 5/8

STOPS



OB2501
1/2 X 1/2



OB2502
3/8 X 9/16



OB2503
3/8 X 3/8

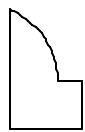

OB2504
3/8 X 5/8



OB2505
3/8 X 11/16



OB2506
1/4 X 1/2



OB2507
1/4 X 3/8



OB2508
1/4 X 3/8

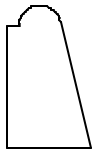

OB2509
7/16 X 3/4

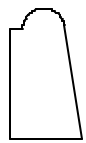

OB2510
3/8 X 11/16



OB2511
3/8 X 1/2

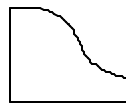

OB2512
1/2 X 5/8



OB2513
1/2 X 9/16



OB2514
1/2 X 1/2

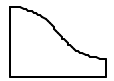

OB2515
3/8 X 1/2

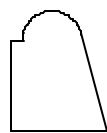

OB2516
1/2 X 5/8



OB2517
1/2 X 5/8

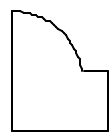

OB2518
1/2 X 5/8

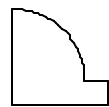

OB2519
1/2 X 1/2

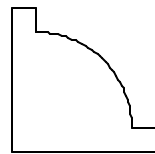

OB2520
3/4 X 3/4

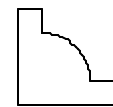

OB2521
1/2 X 1/2

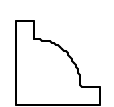

OB2522
7/16 X 7/16

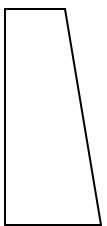

OB2523
1/2 X 1 1/8

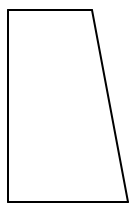

OB2524
5/8 X 1

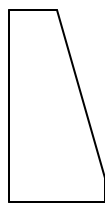

OB2525
1/2 X 1

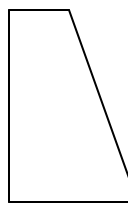

OB2526
5/8 X 1

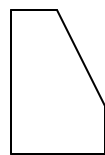

OB2527
1/2 X 3/4

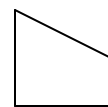

OB2528
1/2 X 1/2

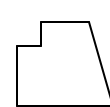

OB2529
7/16 X 1/2

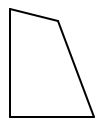

OB2530
7/16 X 9/16

ALL MOULDINGS ARE MADE TO ORDER AND ARE AVAILABLE IN ANY SPECIES OF WOOD.

PICTURE MOULDINGS

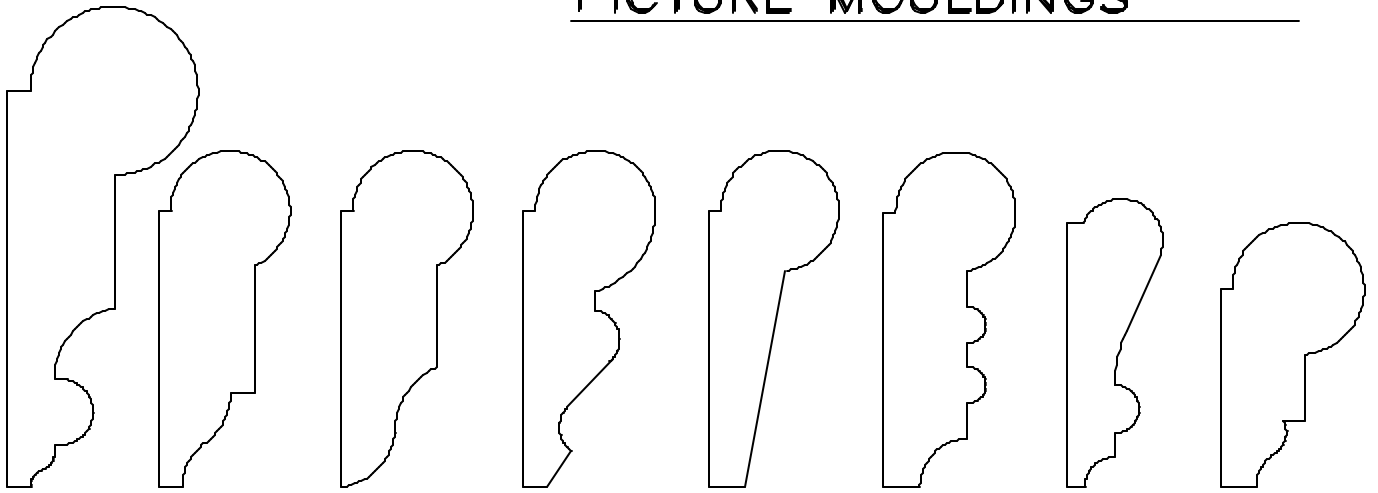

OB2601 1 X 2-1/2 OB2602 11/16 X 1-3/4 OB2603 11/16 X 1-3/4 OB2604 11/16 X 1-3/4 OB2605 11/16 X 1-3/4 OB2606 11/16 X 1-3/4 OB2607 1/2 X 1-1/2 OB2608 3/4 X 1-3/8

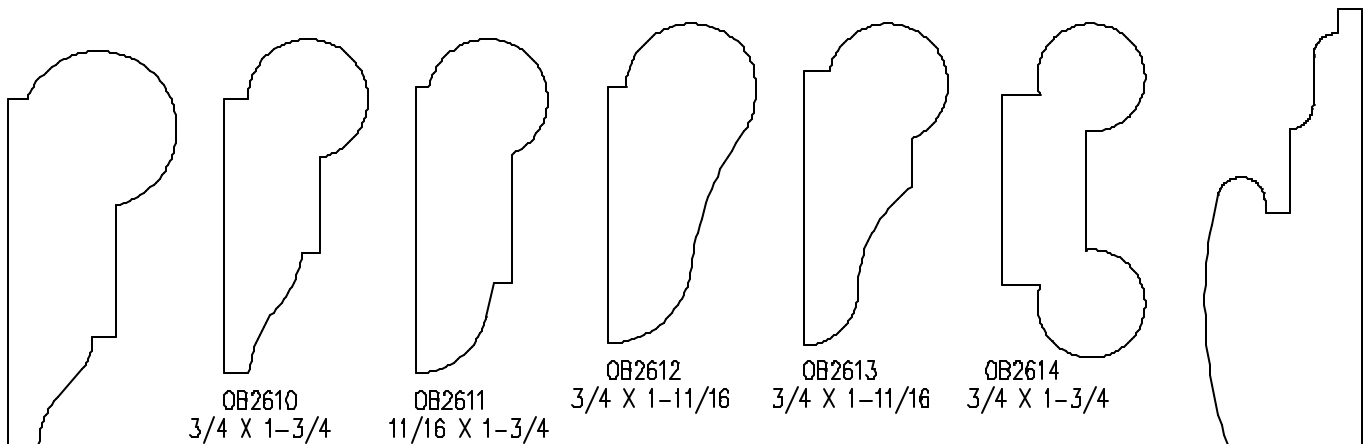

OB2609 7/8 X 2-1/16 OB2610 3/4 X 1-3/4 OB2611 11/16 X 1-3/4 OB2612 3/4 X 1-11/16 OB2613 3/4 X 1-11/16 OB2614 3/4 X 1-3/4

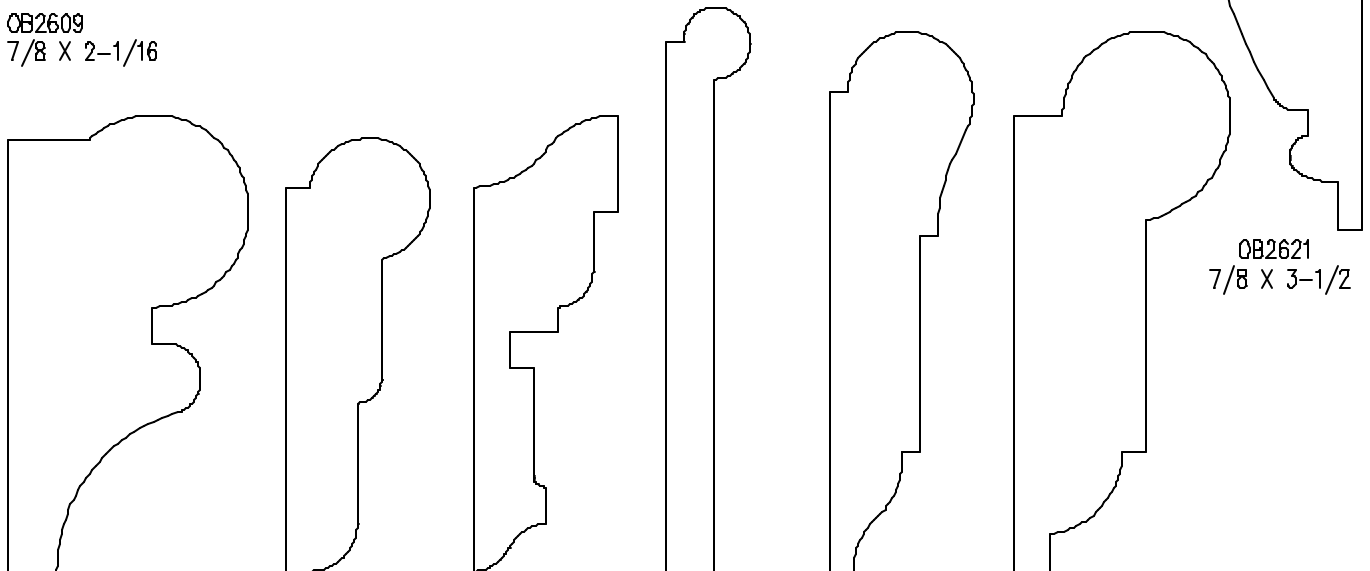

OB2615 1-1/4 X 2-3/8 OB2616 3/4 X 2-1/4 OB2617 3/4 X 2-3/8 OB2618 7/16 X 2-15/16 OB2619 3/4 X 2-13/16 OB2620 1-1/8 X 2-13/16

OB2621 7/8 X 3-1/2

CORNER MOULDINGS

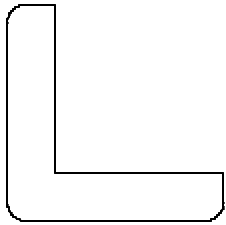

OB2701
1-1/8 X 1-1/8

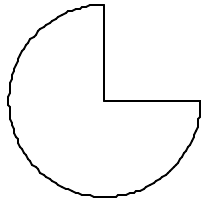

OB2703
1 X 1

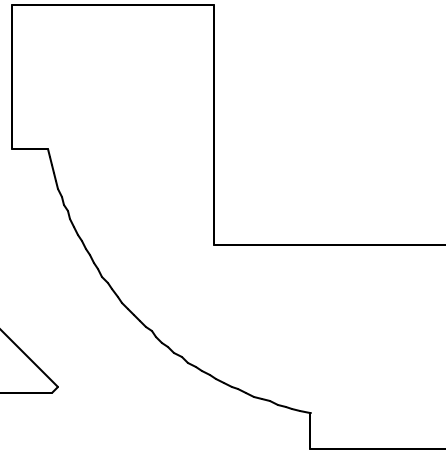

OB2705
1-7/16 X 3-1/4

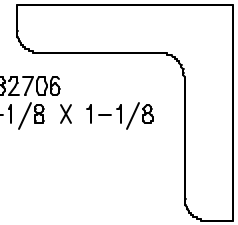

OB2706
1-1/8 X 1-1/8

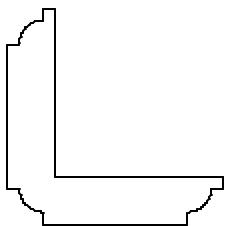

OB2702
1-1/8 X 1-1/8

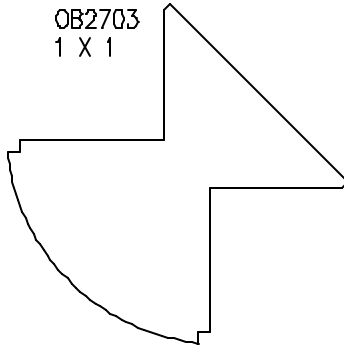

OB2704
1-3/8 X 1-7/16

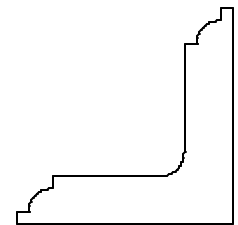

OB2707
1-1/8 X 1-1/8

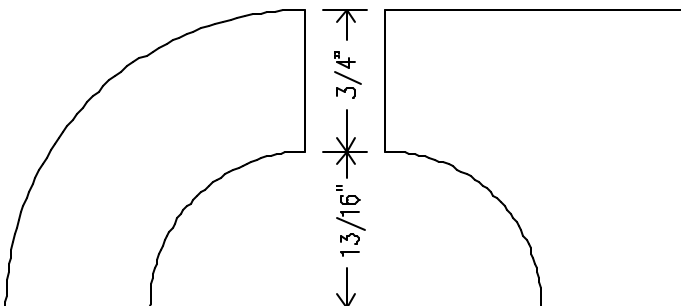

OB2708
1 X 2-1/4

OB2709
1-9/16 X 1-9/16

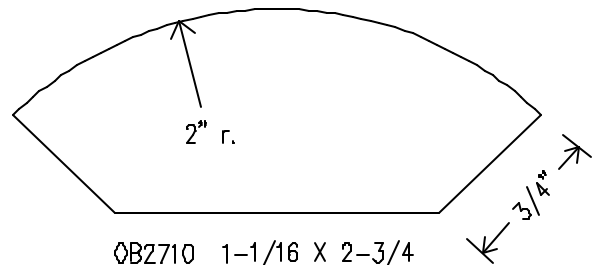

OB2710 1-1/16 X 2-3/4

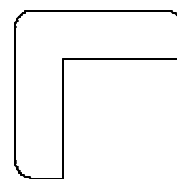

OB2711
7/8 X 7/8

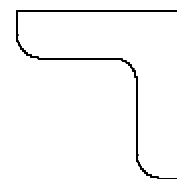

OB2712
7/8 X 7/8

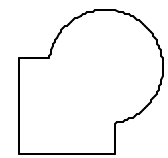

OB2713
3/4 X 3/4

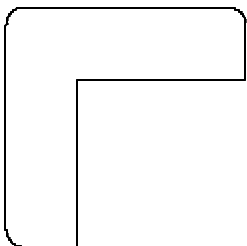

OB2714
1-1/4 X 1-1/4

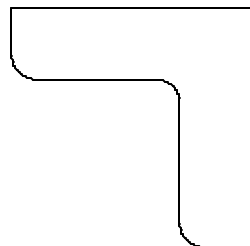

OB2715
1-1/4 X 1-1/4

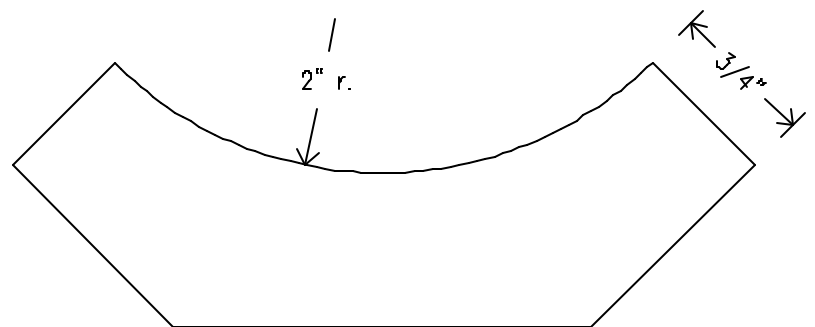

OB2716 1-3/8 X 3-7/8

ALL MOULDINGS ARE MADE TO ORDER AND ARE AVAILABLE IN ANY SPECIES OF WOOD.

BACK BANDS

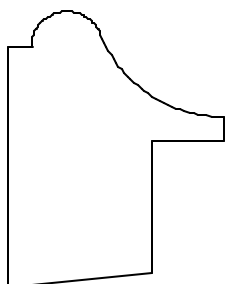

OB2801
1 1/8 X 1 7/16

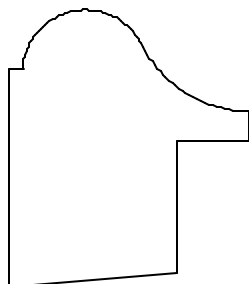

OB2802
1 1/4 X 1 7/16

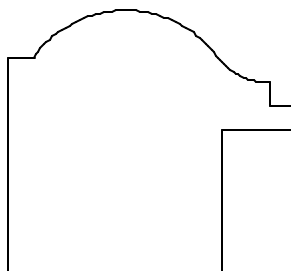

OB2803
1 3/8 X 1 1/2

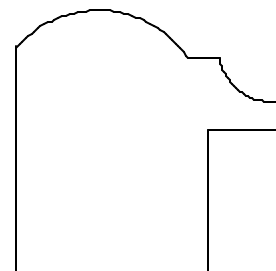

OB2804
1 3/8 X 1 3/8

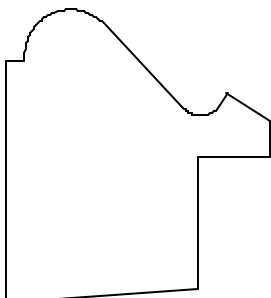

OB2805
1 3/8 X 1-1/2

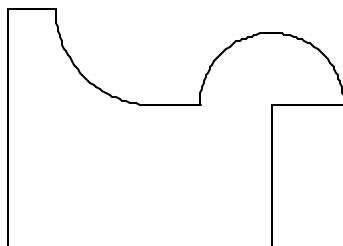

OB2806
1 1/4 X 1 3/4

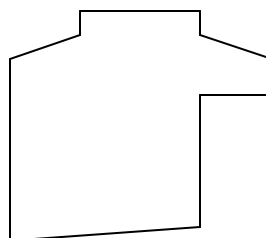

OB2807
1 3/16 X 1 3/8

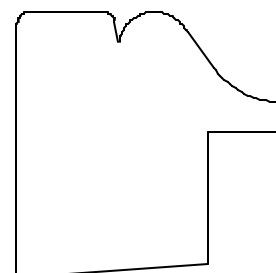

OB2808
1 3/8 X 1 3/8

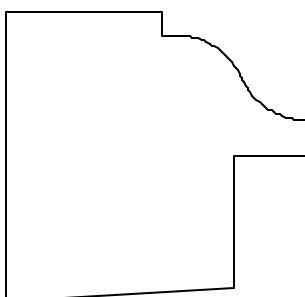

OB2809
1 1/2 X 1 9/16

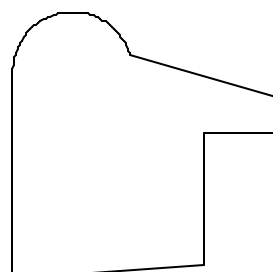

OB2810
1 3/8 X 1 3/8

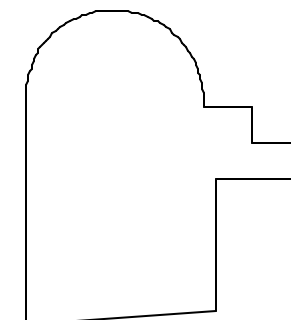

OB2811
1 7/16 X 1 5/8

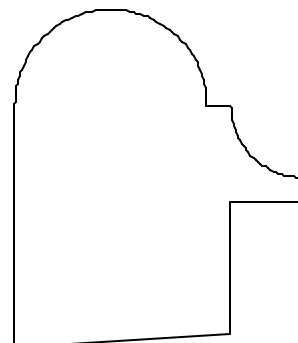

OB2812
1 1/2 X 1 3/4

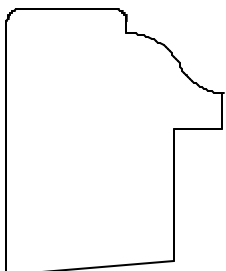

OB2813
1 1/8 X 1 3/8

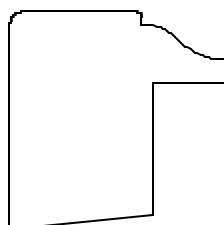

OB2814
1 1/8 X 1 1/8

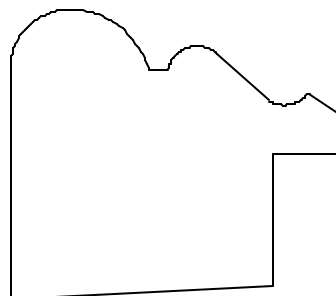

OB2815
1 1/2 X 1 3/4

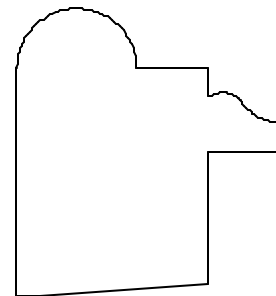

OB2816
1 3/8 X 1 1/2

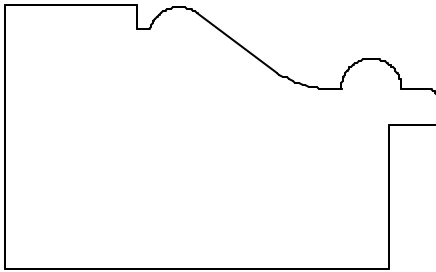

OB2817
1-3/8 X 2-1/4

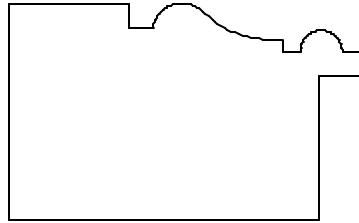

OB2818
1-1/8 X 1-7/8

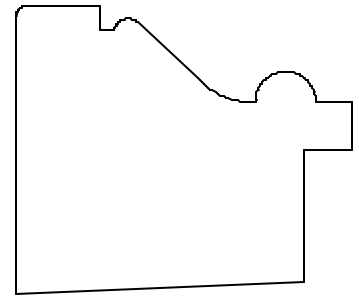

OB2819
1-1/2 X 1-3/4

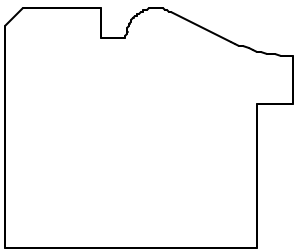

OB2820
1-1/4 X 1-1/2



OB2821
1-1/4 X 1-1/2

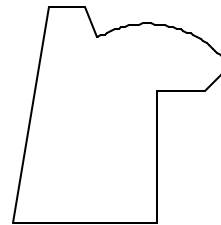

OB2822
1-1/8 X 1-1/8

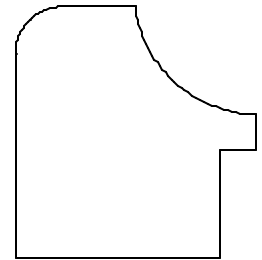

OB2823
1-5/16 X 1-1/4

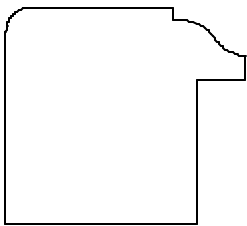

OB2824
1-1/8 X 1-1/4

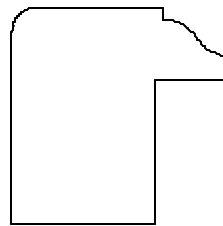

OB2825
1-1/8 X 1-1/8

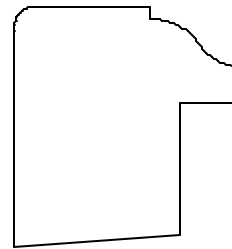

OB2826
1-1/4 X 1-3/16

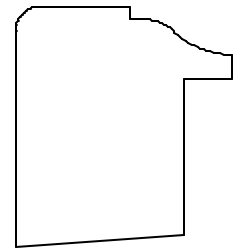

OB2827
1-1/4 X 1-1/8

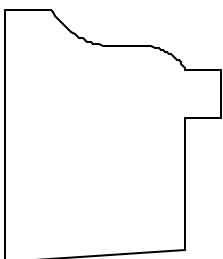

OB2828
1-5/16 X 1-1/8

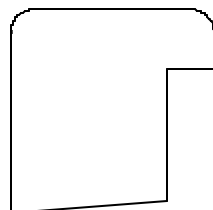

OB2829
1-1/16 X 1-1/16

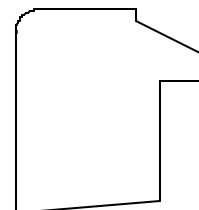

OB2830
1-1/16 X 1

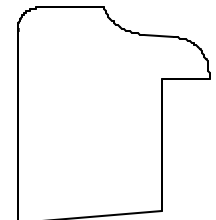

OB2831
1-1/8 X 1

ALL MOULDINGS ARE MADE TO ORDER AND ARE AVAILABLE IN ANY SPECIES OF WOOD.

RAILINGS

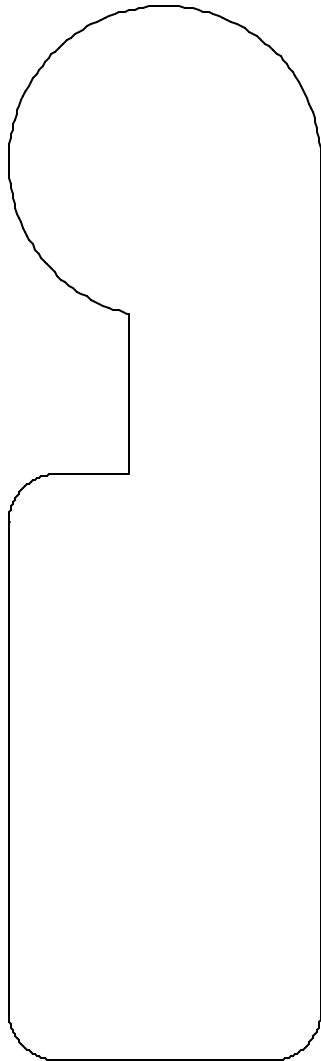

OB2901
1-5/8 X 5-1/2

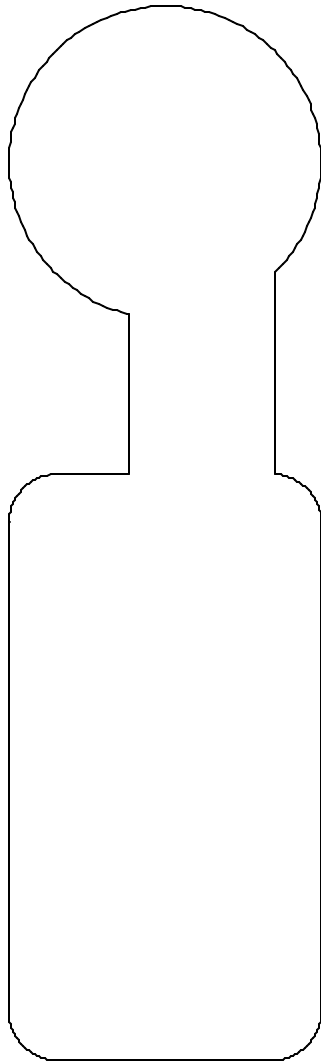

OB2902
1-5/8 X 5-1/2

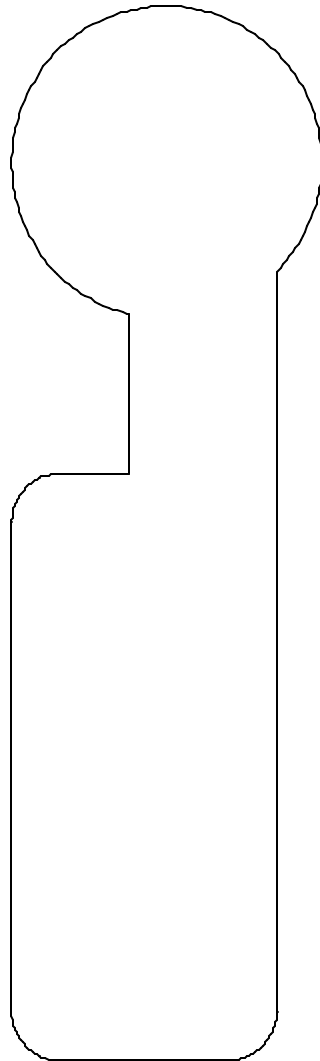

OB2903
1-5/8 X 5-1/2

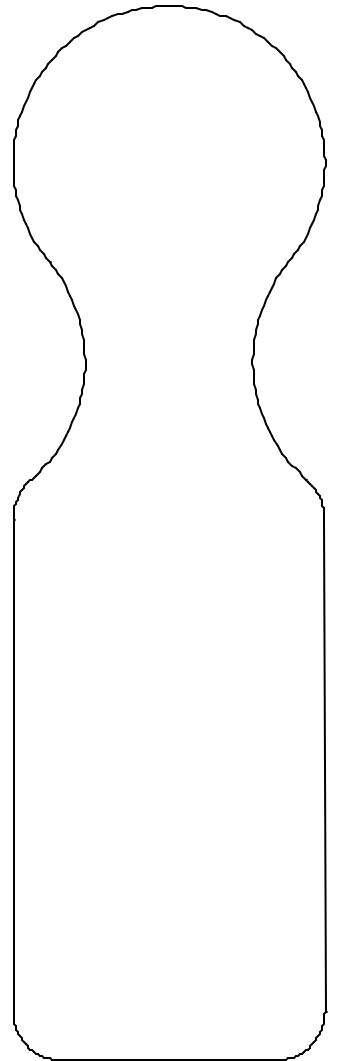

OB2904
1-5/8 X 5-1/2

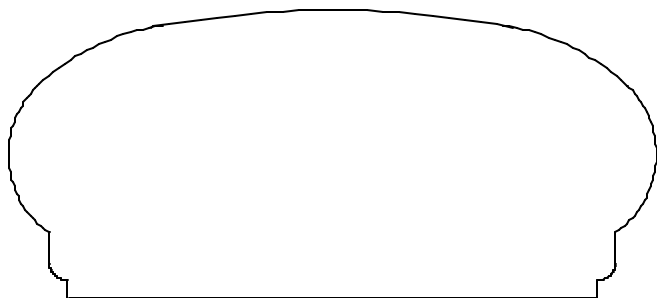

OB2905 1-1/2 X 3-3/8

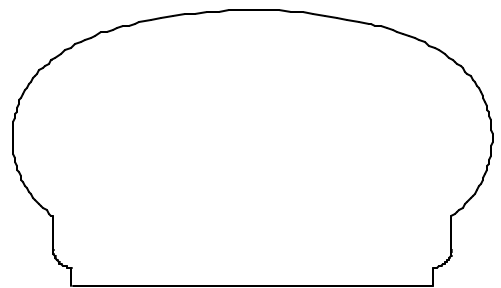

OB2906 1-7/16 X 3-3/8

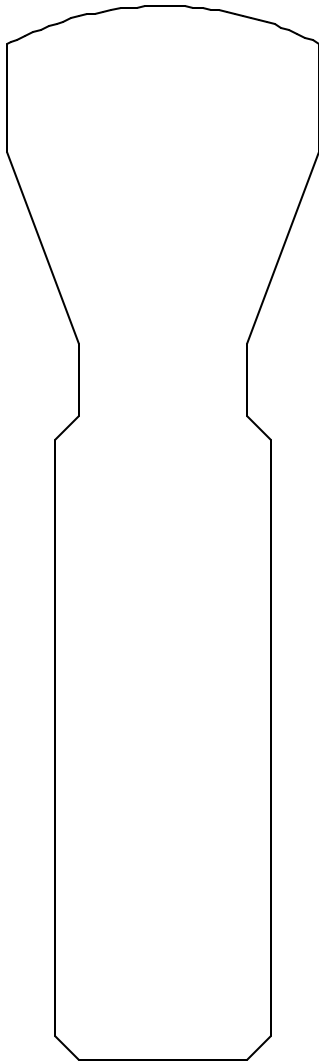

OB2907
1-5/8 x 5-1/2

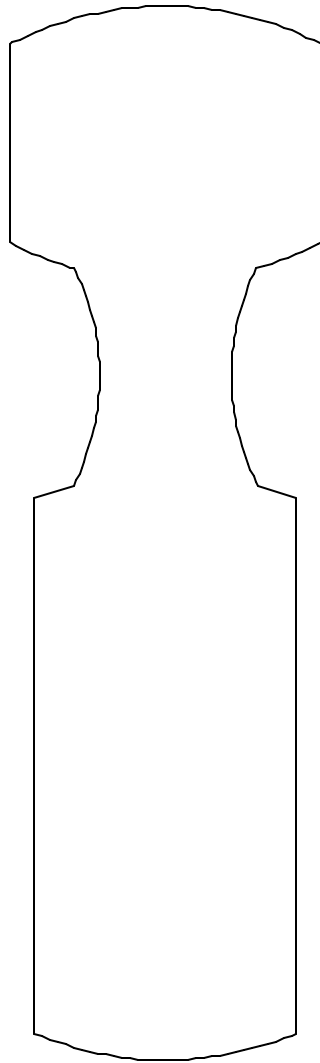

OB2908
1-5/8 X 5-1/2

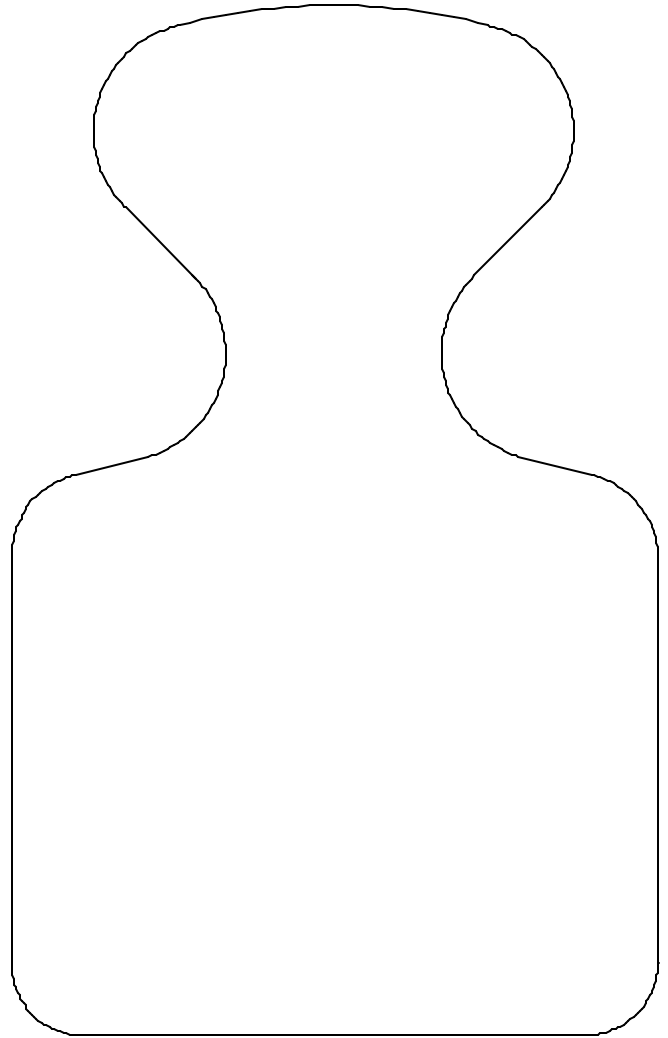

OB2909 3-3/8 X 5-3/8

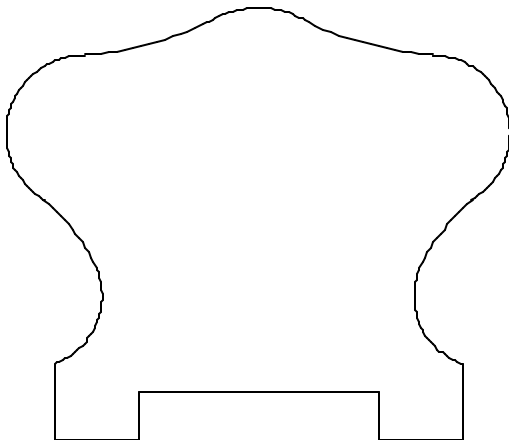

OB2910 2-1/4 X 2-5/8

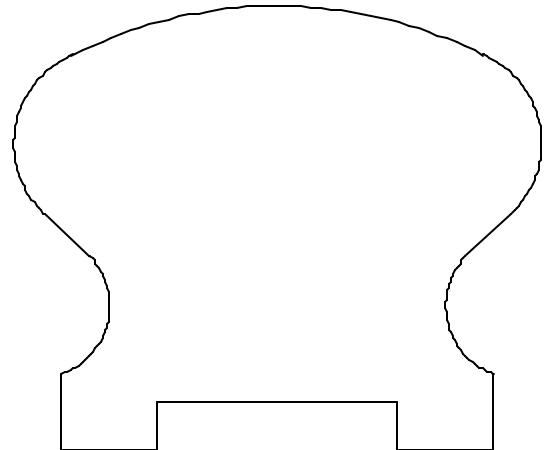

OB2911 2-5/16 X 2-3/4

ALL MOULDINGS ARE MADE TO ORDER AND ARE AVAILABLE IN ANY SPECIES OF WOOD.
FLOW SIZE CAN BE CHANGED OR DELETED

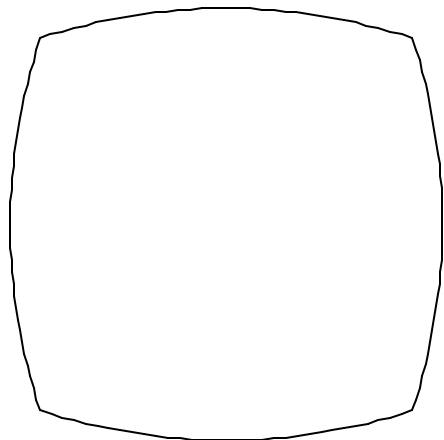

OB2912 2-1/4 X 2-1/4

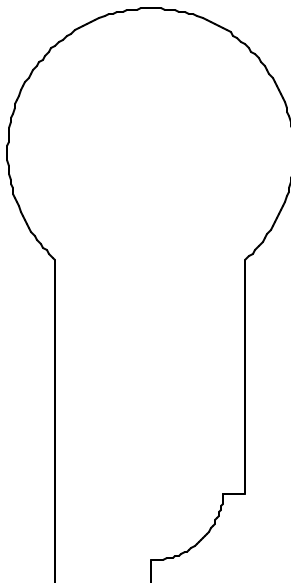

OB2913
1-1/2 X 3

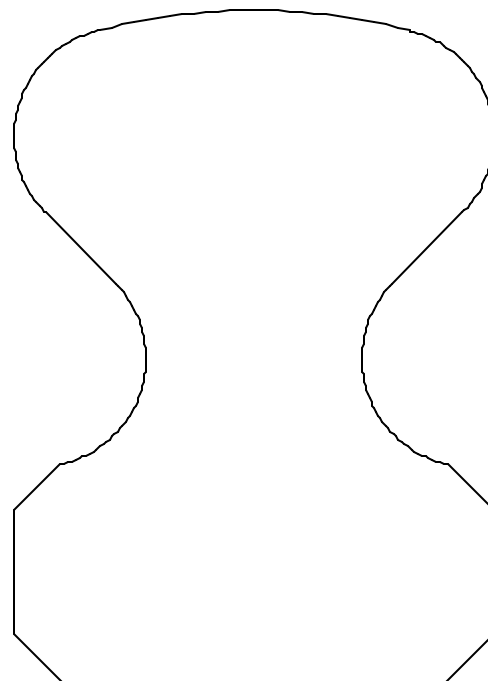

OB2914 2-1/2 X 3-1/2

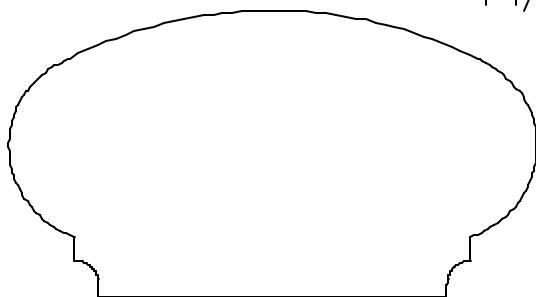

OB2915 1-1/2 X 2-3/4

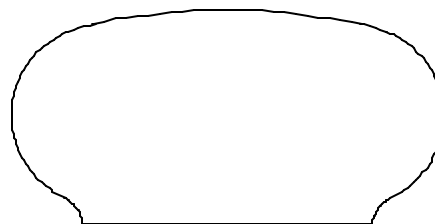

OB2916 1-1/8 X 2-1/4

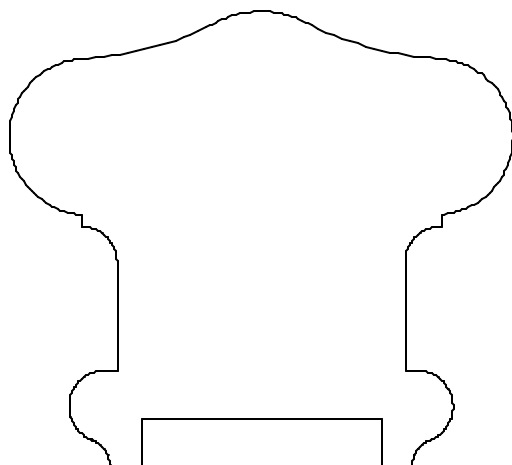

OB2917 2-3/8 X 2-5/8

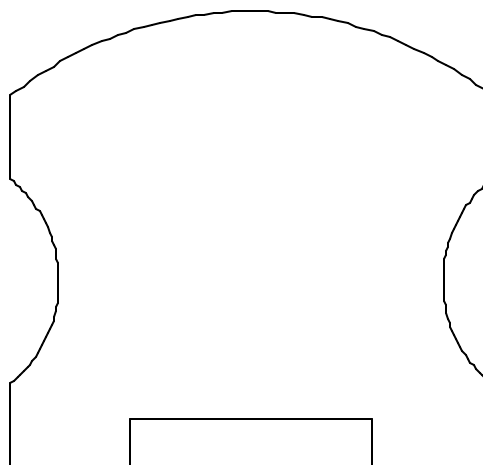

OB2918 2-3/8 X 2-1/2

ALL MOULDINGS ARE MADE TO ORDER AND ARE AVAILABLE IN ANY SPECIES OF WOOD.
FLOWS OPTIONAL AND ADJUSTABLE

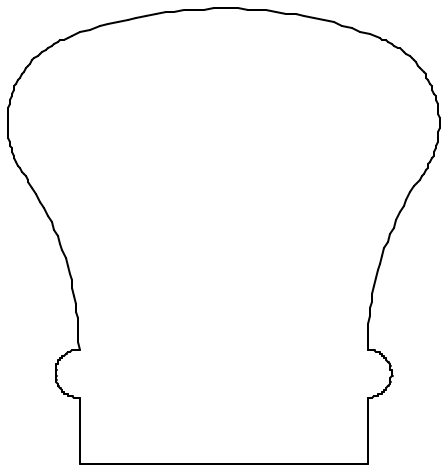

OB2919 2-1/4 X 2-5/8

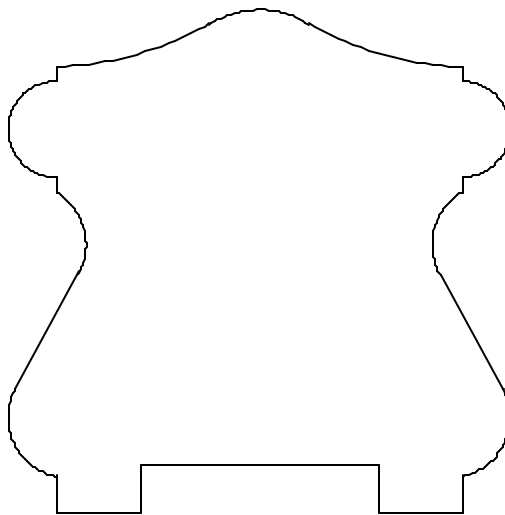

OB2920 2-5/8 X 2-5/8

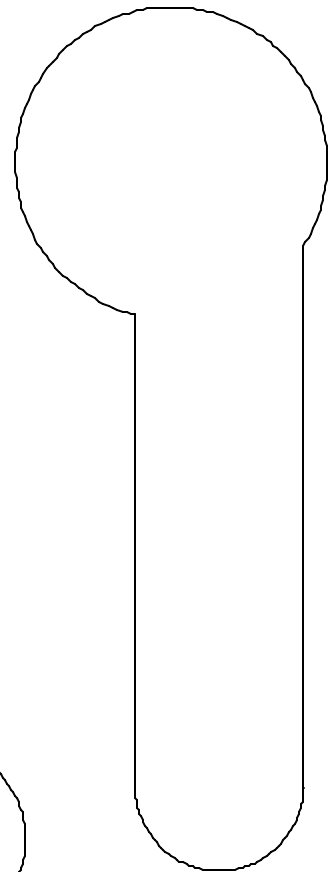

OB2921
1-5/8 X 4-1/2

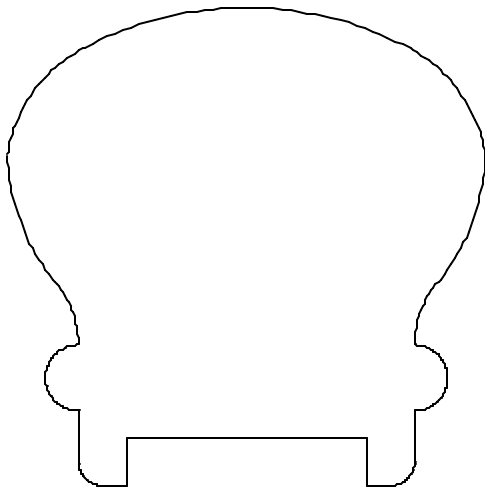

OB2922 2-1/2 X 2-1/2

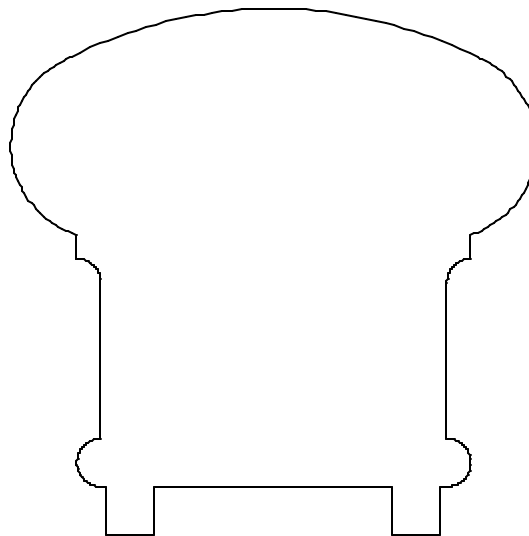

OB2923 2-3/4 X 2-3/4

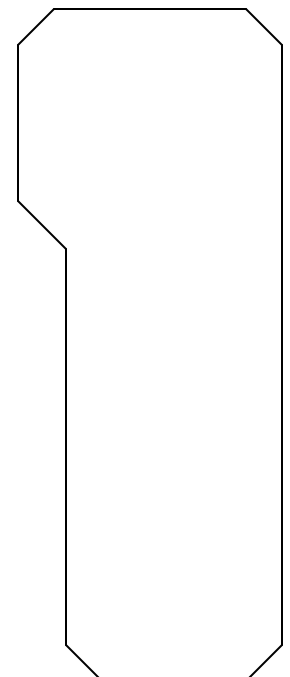

OB2926
1-3/8 X 3-1/2

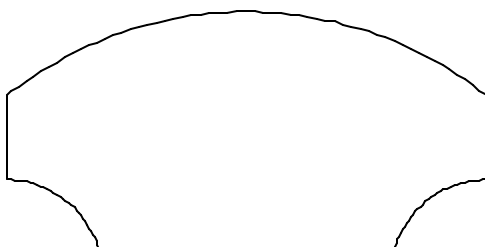

OB2924 1-1/4 X 2-1/2

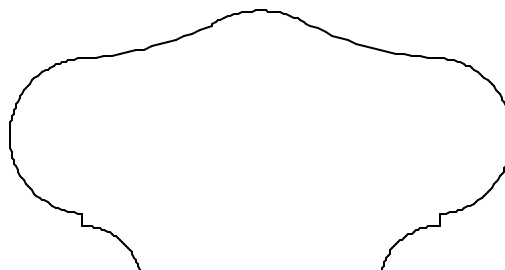

OB2925 1-3/8 X 2-5/8

ALL MOULDINGS ARE MADE TO ORDER AND ARE AVAILABLE IN ANY SPECIES OF WOOD.
FLOW SIZES CAN BE CHANGED OR DELETED

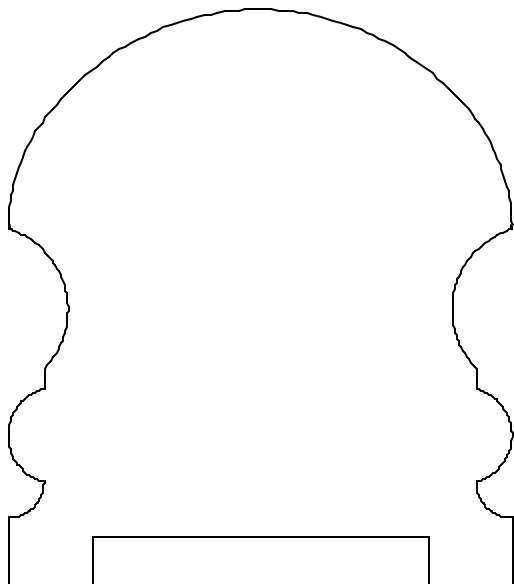

OB2927 2-5/8 X 3

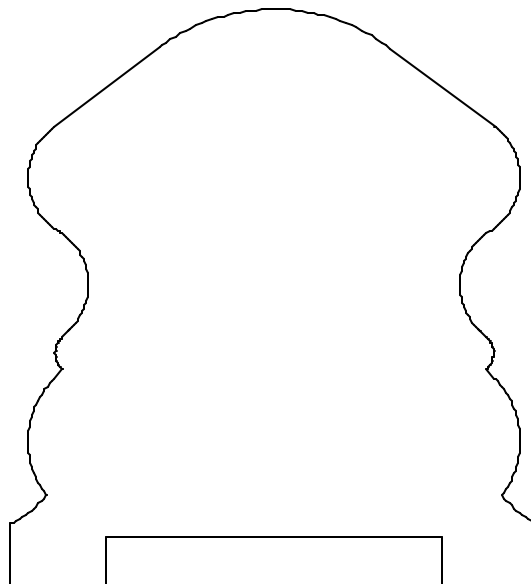

OB2928 2-3/4 X 3

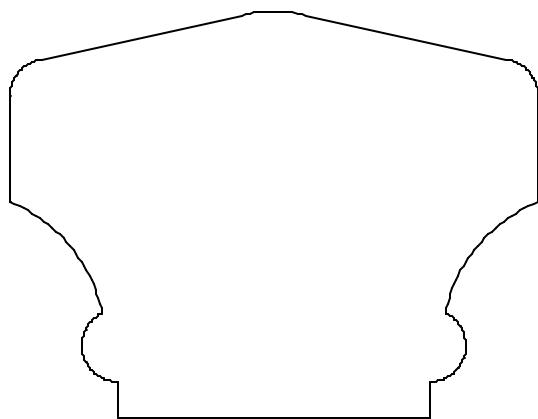

OB2929 2-1/8 X 2-3/4

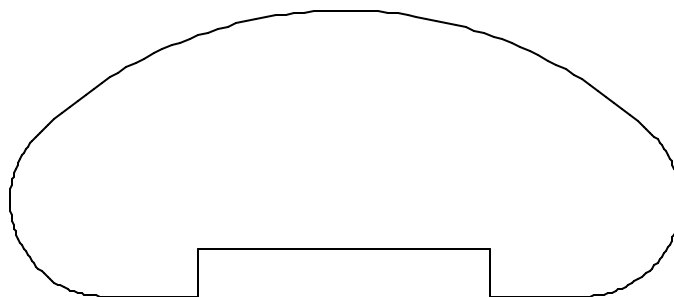

OB2930 1-1/2 X 3-1/2

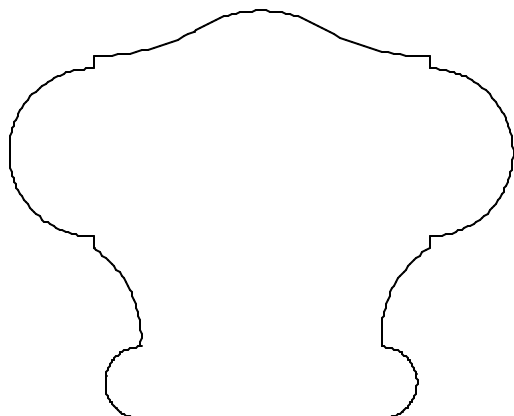

OB2931 2-1/8 X 2-5/8

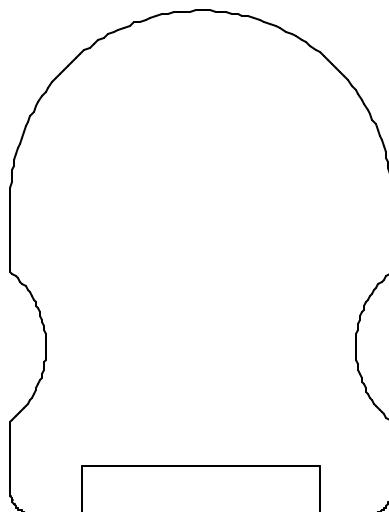

OB2932 2 X 2-5/8

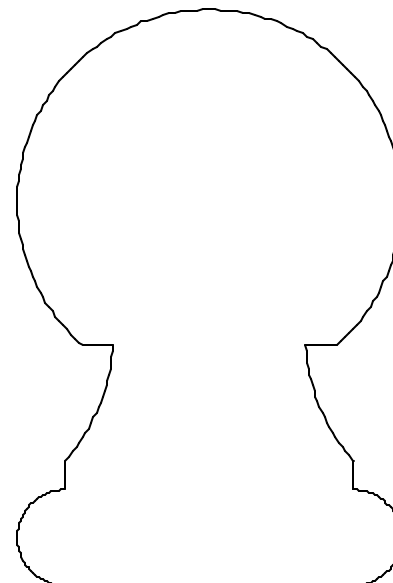

OB2933 2 X 3

ALL MOULDINGS ARE MADE TO ORDER AND ARE AVAILABLE IN ANY SPECIES OF WOOD.
FLWS OPTIONAL AND ADJUSTABLE

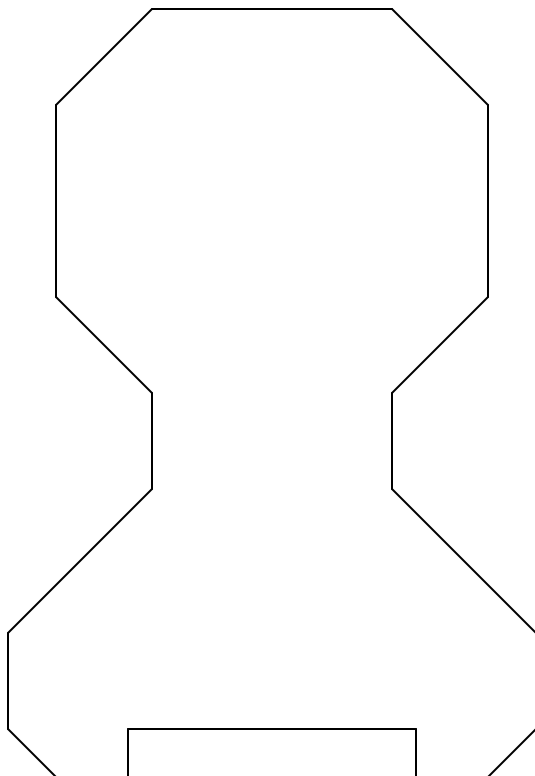

OB2934 2-3/4 X 4

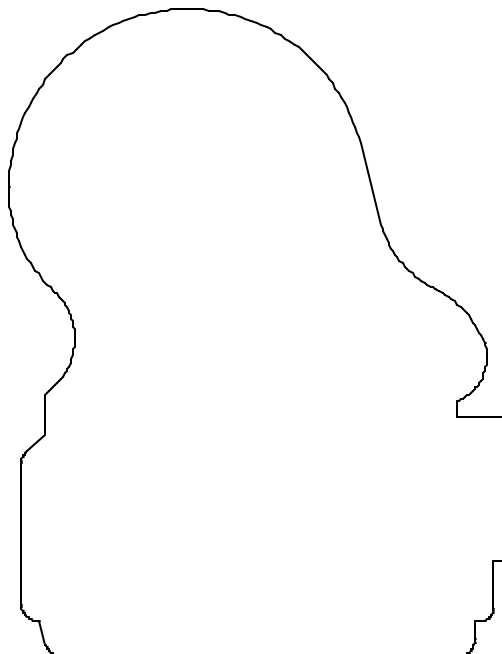

OB2935 2-5/8 X 3-3/8

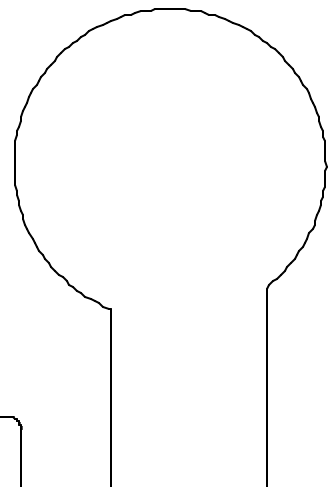

OB2936
1-5/8 X 2-1/2

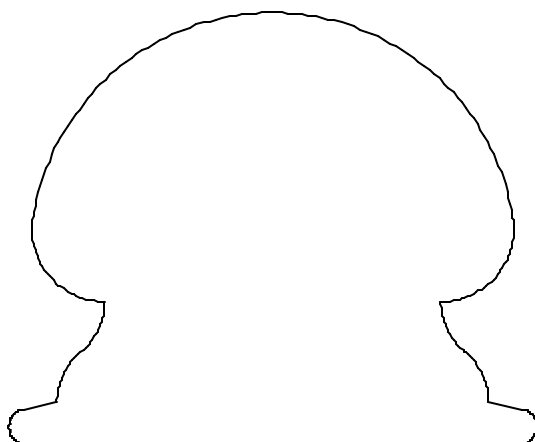

OB2937 2-3/4 X 2-1/4

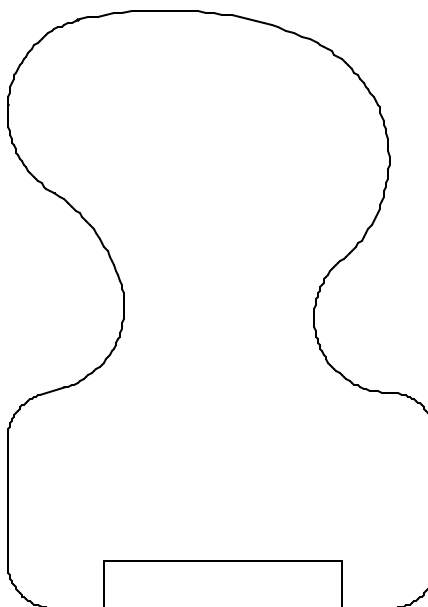

OB2938 2-1/4 X 3-1/8

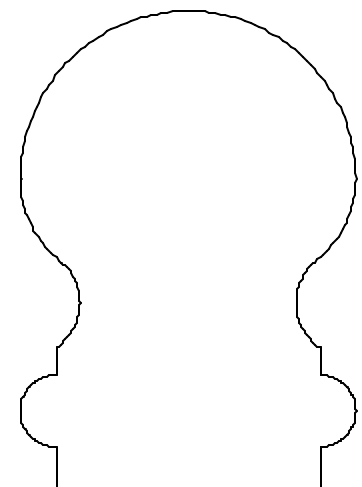

OB2939 1-3/4 X 2-1/2

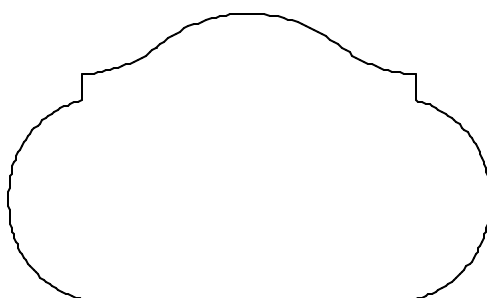

OB2941 2-1/2 X 1-1/2

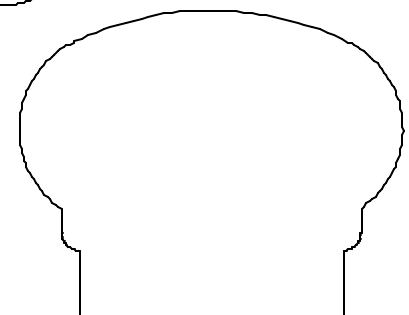

OB2940 2 X 1-5/8

ALL MOULDINGS ARE MADE TO ORDER AND ARE AVAILABLE IN ANY SPECIES OF WOOD.
FLOWS OPTIONAL AND ADJUSTABLE

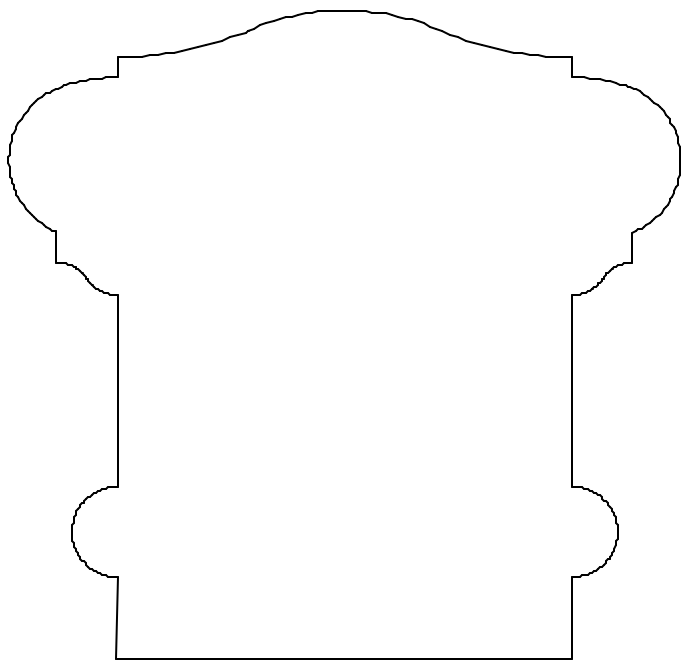

OB2942 3-1/2 X 3-3/8

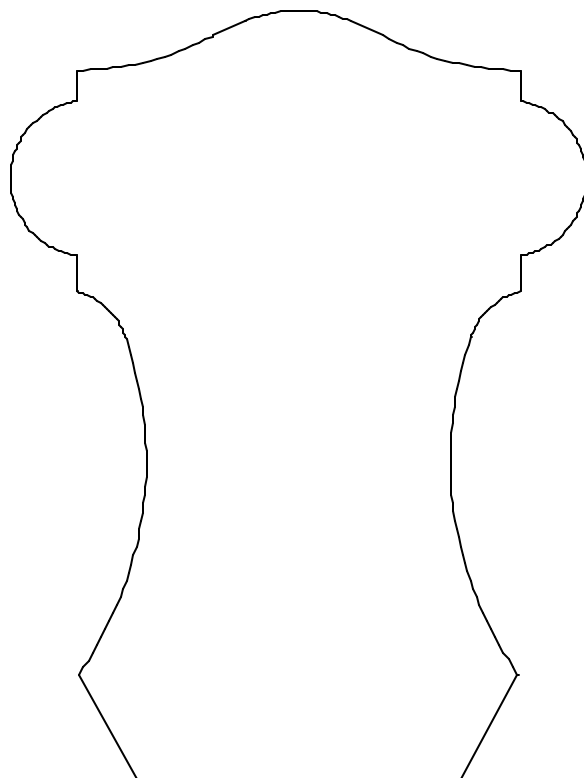

OB2943 3 X 4

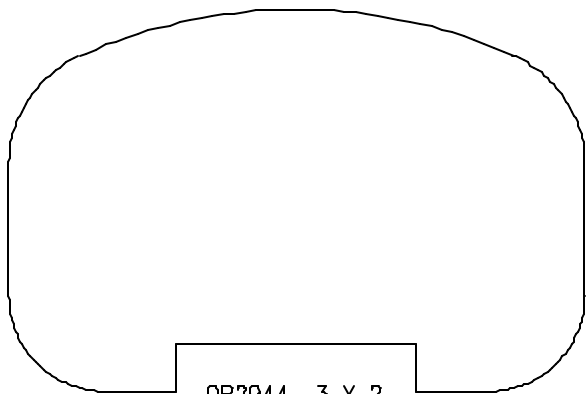

OB2944 3 X 2

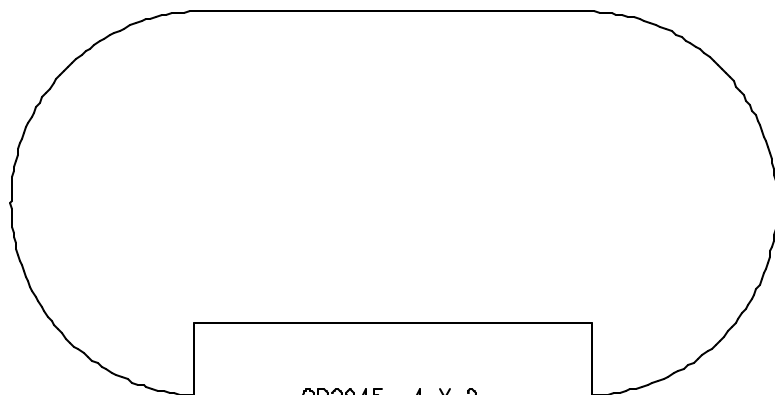

OB2945 4 X 2

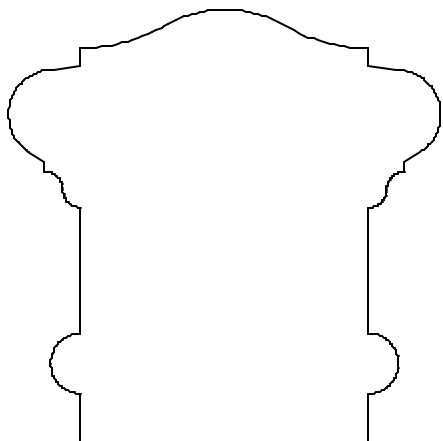

OB2946 2-1/4 X 2-1/4

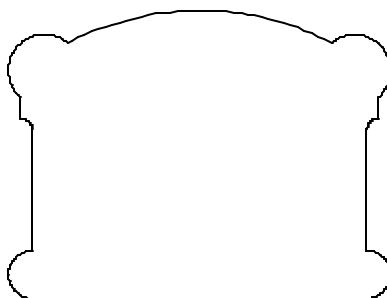

OB2947 2 X 1 1/2

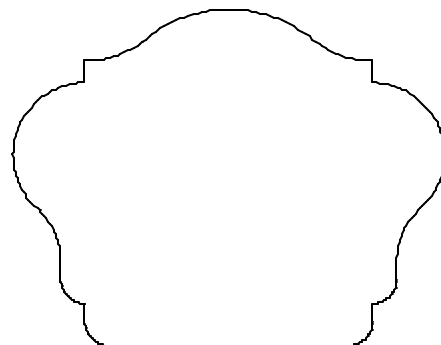

OB2948 2-1/4 X 1-3/4

ALL MOULDINGS ARE MADE TO ORDER AND ARE AVAILABLE IN ANY SPECIES OF WOOD.
FLOWS OPTIONAL AND ADJUSTABLE

O.B. WILLIAMS COMPANY

ESTABLISHED 1889

1939 FIRST AVE. SO. SEATTLE, WASHINGTON 98134 (206) 623-2494 FAX 623-2602

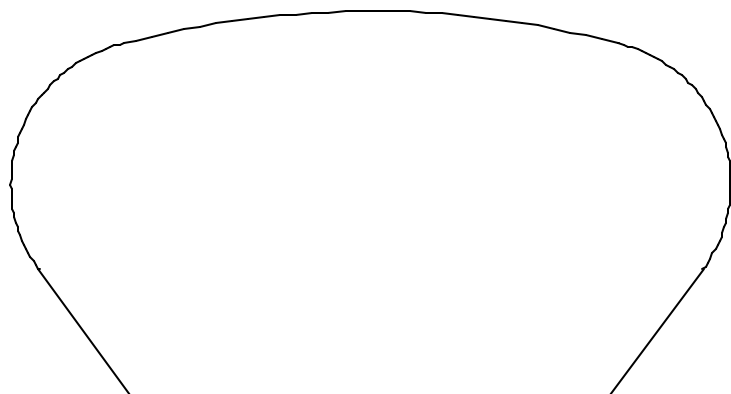

OB2949 3-3/4 X 2

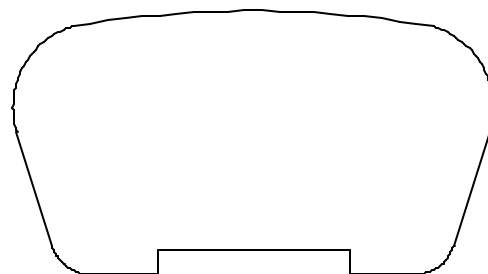

OB2950 2-1/2 X 1-3/8

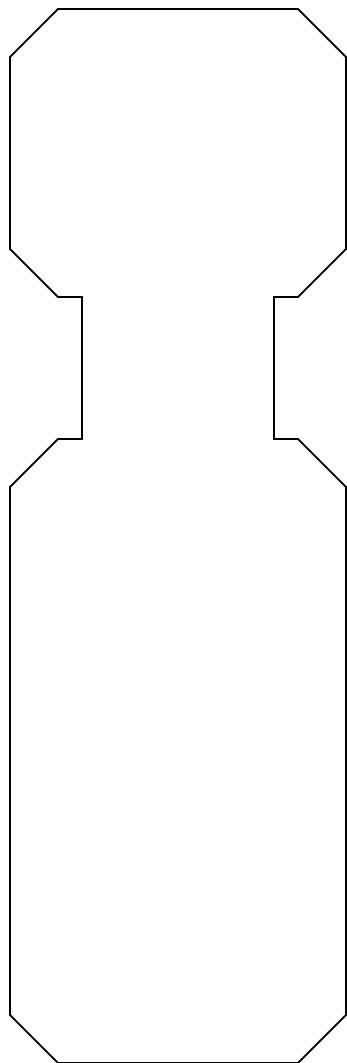

OB2951 1-3/4 X 5-1/2

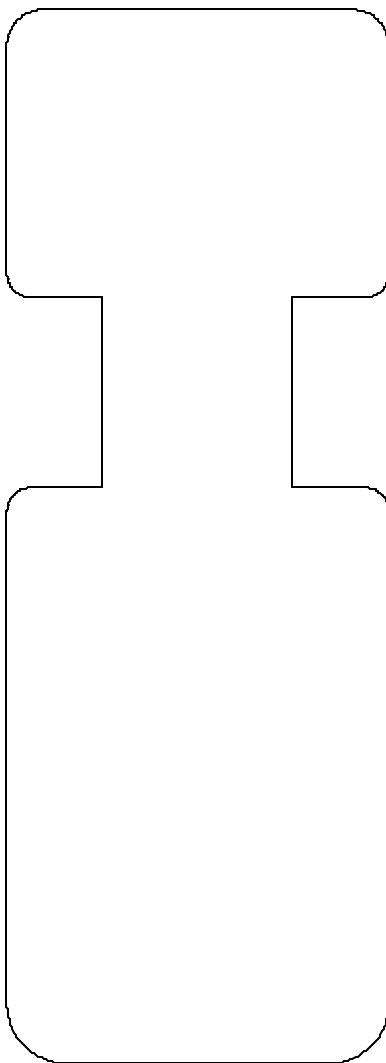

OB2952 2 X 5-1/2

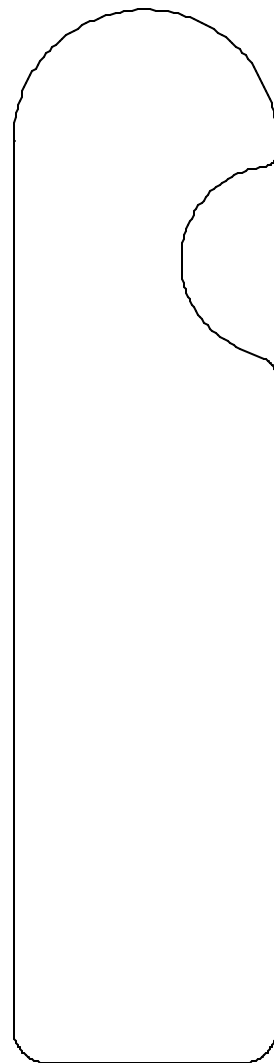

OB2953 1-3/8 X 5-1/2

ALL MOULDINGS ARE MADE TO ORDER AND ARE AVAILABLE IN ANY SPECIES OF WOOD.
BOTTOM FLOWS OPTIONAL AND ADJUSTABLE

O.B. WILLIAMS COMPANY

ESTABLISHED 1889

1939 FIRST AVE. SO. SEATTLE, WASHINGTON 98134 (206) 623-2494 FAX 623-2602

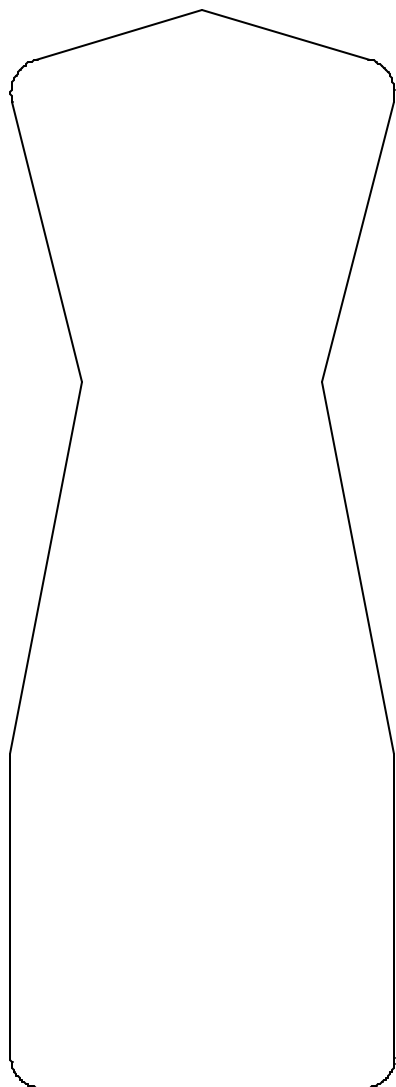

OB2954 2 X 5-5/8

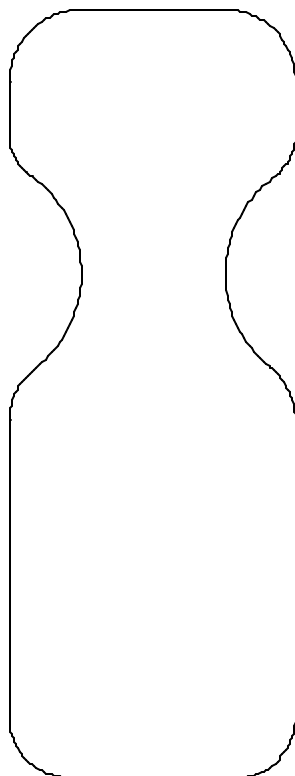

OB2955 1-1/2 X 4

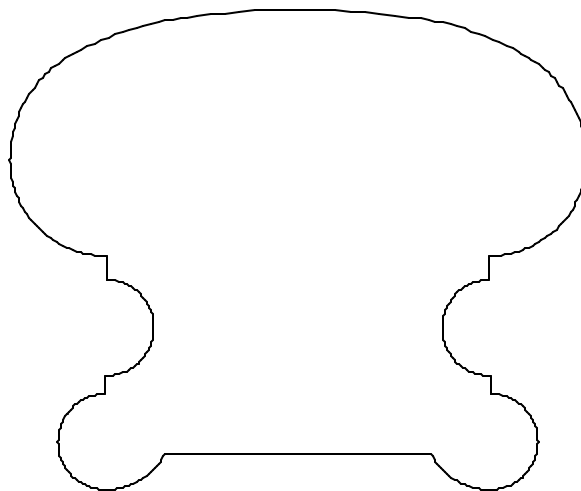

OB2956 2-7/8 X 2-1/2

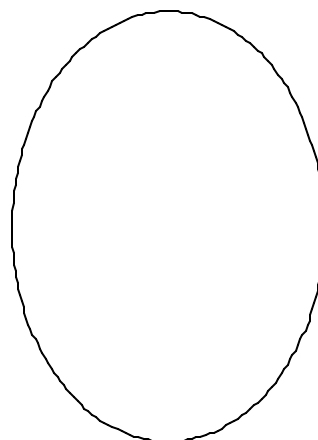

OB2957
1-5/8 X 2-1/4

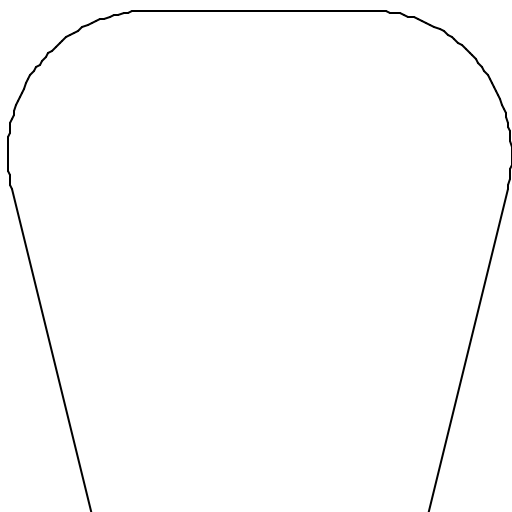

OB2958 2-5/8 X 2-5/8

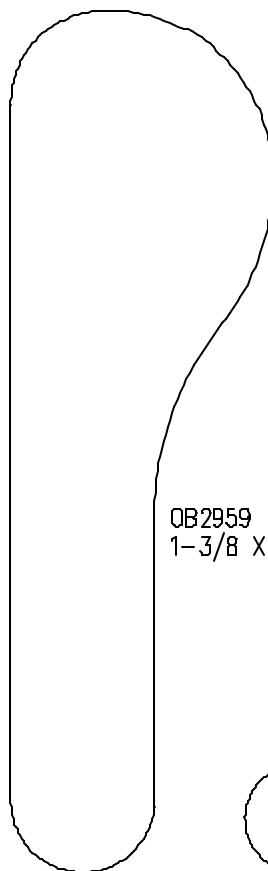

OB2959
1-3/8 X 4-1/2

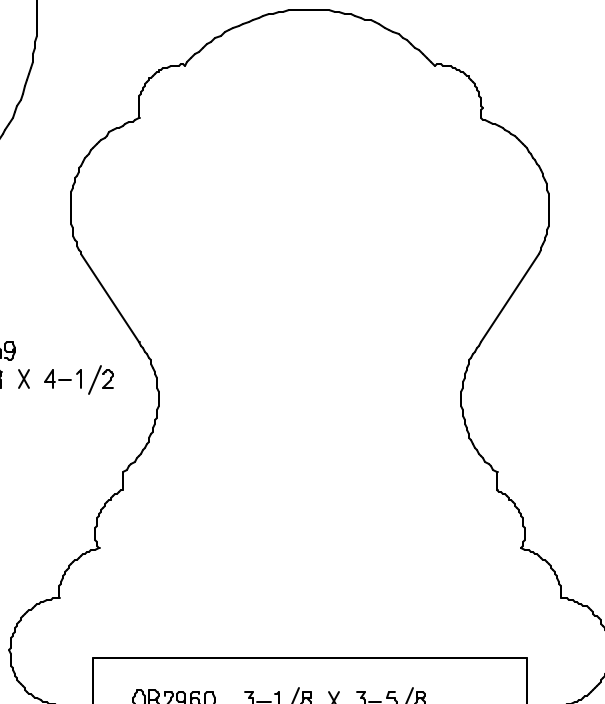

OB2960 3-1/8 X 3-5/8

ALL MOULDINGS ARE MADE TO ORDER AND ARE AVAILABLE IN ANY SPECIES OF WOOD.
BOTTOM FLOWS OPTIONAL AND ADJUSTABLE

BAR RAILS

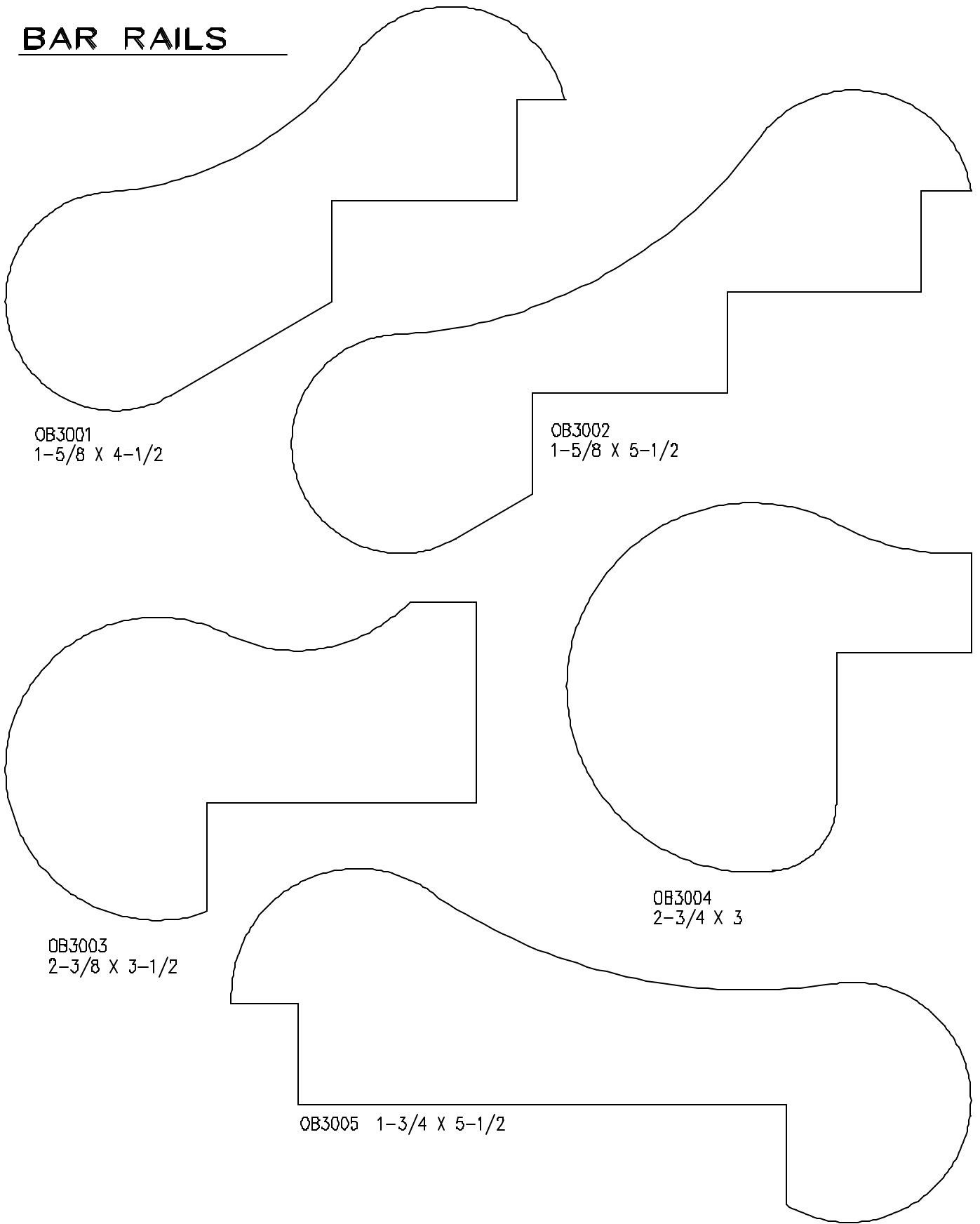

OB3001
1-5/8 X 4-1/2

OB3002
1-5/8 X 5-1/2

OB3003
2-3/8 X 3-1/2

OB3004
2-3/4 X 3

OB3005 1-3/4 X 5-1/2

PANEL MOULDINGS

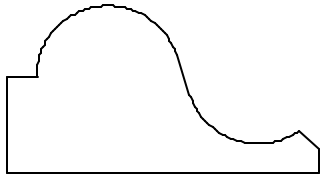

OB3101
7/8 X 1-5/8



OB3102
3/4 X 1-3/8

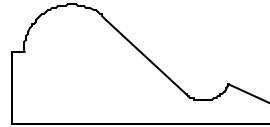

OB3103
5/8 X 1-3/8



OB3104
11/16 X 1-1/8



OB3105
1/2 X 1-1/16



OB3106
3/8 X 1-1/8



OB3107
3/8 X 1

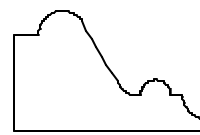

OB3108
5/8 X 1

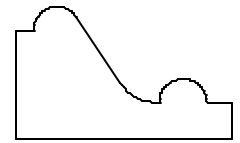

OB3109
11/16 X 1-1/8

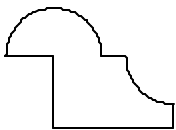

OB3110
5/8 X 7/8

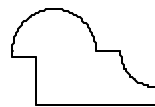

OB3111
1/2 X 3/4



OB3112
3/8 X 5/8

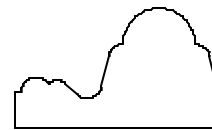

OB3113
5/8 X 1-1/16

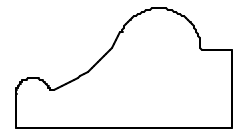

OB3114
5/8 X 1-1/8



OB3115
5/8 X 3/4

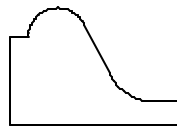

OB3116
5/8 X 7/8

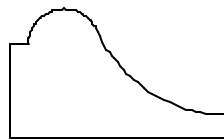

OB3117
11/16 X 1-1/8



OB3118
11/16 X 1-1/4



OB3119
3/8 X 1



OB3120
7/16 X 1-1/4

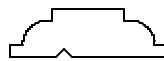

OB3121
1/4 X 13/16



OB3122
3/8 X 3/4



OB3123
3/8 X 1



OB3124
9/16 X 1-1/2



OB3125
1/4 X 1-3/8



OB3126
3/8 X 1



OB3127
3/8 X 1-1/16



OB3128
1/2 X 7/8



OB3129
5/8 X 1-1/8

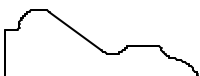

OB3130
3/8 X 1



OB3131
1/2 X 1



OB3132
5/8 X 1-3/8



OB3133
3/4 X 1-13/16

O.B. WILLIAMS COMPANY

ESTABLISHED 1889

1939 FIRST AVE. SO. SEATTLE, WASHINGTON 98134 (206) 623-2494 FAX 623-2602

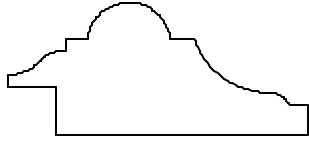

OB3134
11/16 X 1-9/16

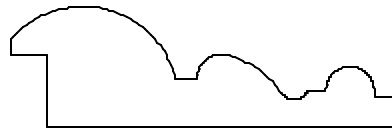

OB3135
5/8 X 2



OB3136
5/8 X 1-1/2

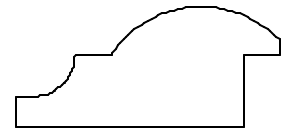

OB3137
5/8 X 1-3/8

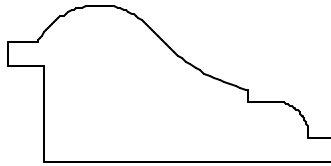

OB3138
13/16 X 1-11/16

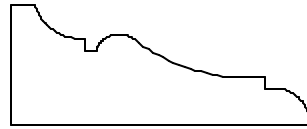

OB3139
5/8 X 1-9/16

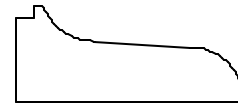

OB3140
1/2 X 1-3/16



OB3141
1/2 X 3/4

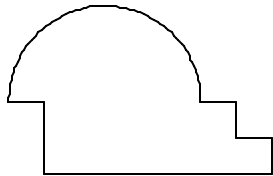

OB3142
7/8 X 1-3/8

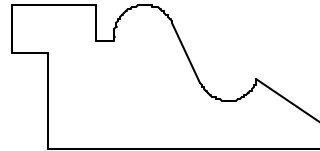

OB3143
3/4 X 1-5/8

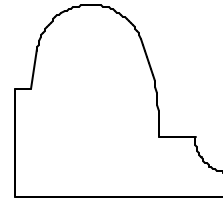

OB3144
1 X 1-1/8

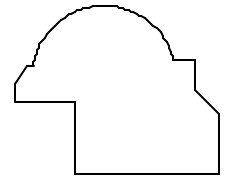

OB3145
7/8 X 1-1/16

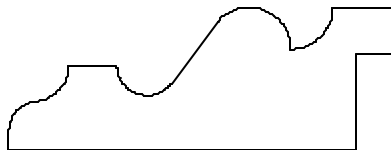

OB3146
3/4 X 2



OB3147
5/8 X 1-3/8



OB3148
5/8 X 1-5/8

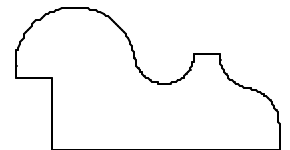

OB3149
3/4 X 1-3/8

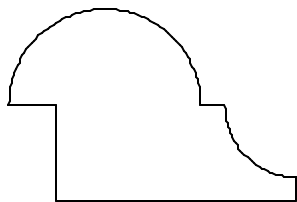

OB3150
1 X 1-1/2

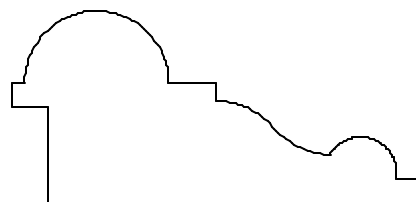

OB3151
1 X 2-1/8

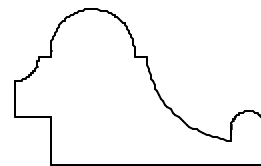

OB3152
5/8 X 1-5/16

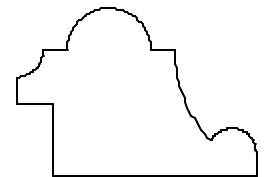

OB3153
7/8 X 1-1/4

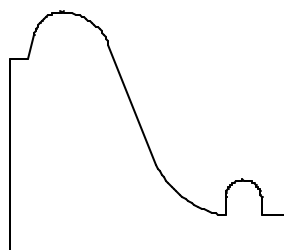

OB3154
1-1/4 X 1-7/16

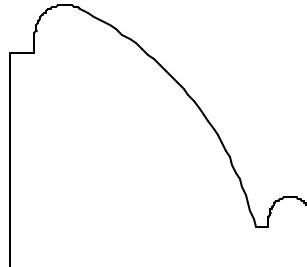

OB3155
1-3/8 X 1-9/16

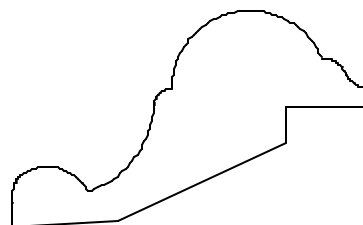

OB3156
3/4 X 2

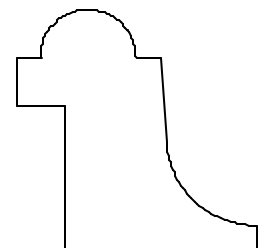

OB3157
1-1/4 X 1-1/4

ALL MOULDINGS ARE MADE TO ORDER AND ARE AVAILABLE IN ANY SPECIES OF WOOD.

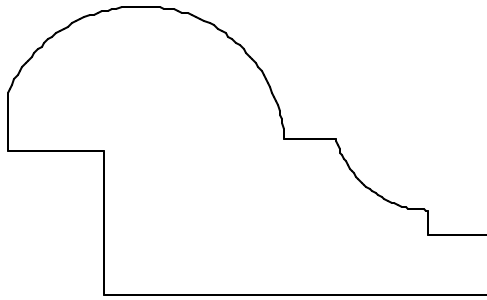

OB3158 1-1/2 X 2-1/2

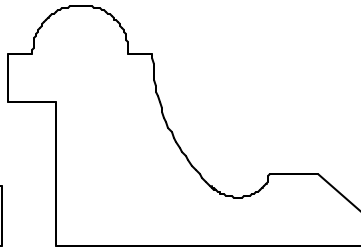

OB3159 1-1/4 X 1-7/8



OB3160 1-1/4 X 2-1/2

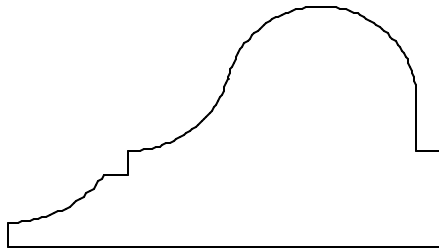

OB3161 1-1/4 X 2-1/4

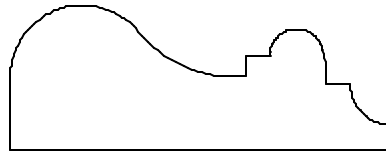

OB3162 3/4 X 2



OB3163 1-1/16 X 1-5/8

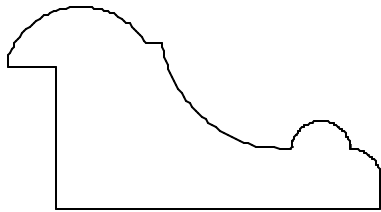

OB3164 1-1/16 X 1-15/16

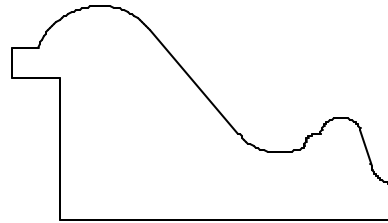

OB3165 1-1/8 X 2

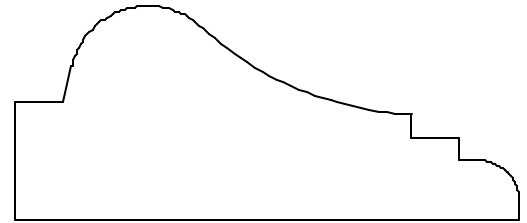

OB3166 1-1/8 X 2-5/8

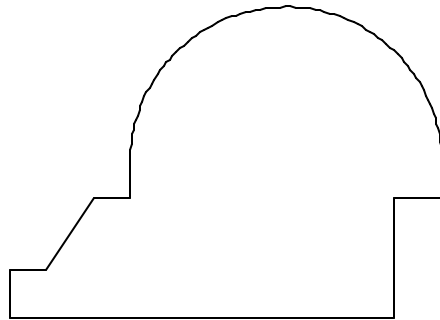

OB3167 1-5/8 X 2-1/4

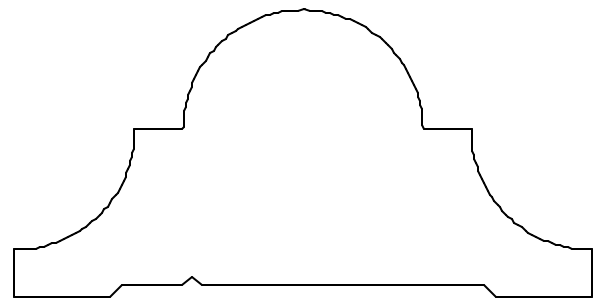

OB3168 1-1/2 X 3

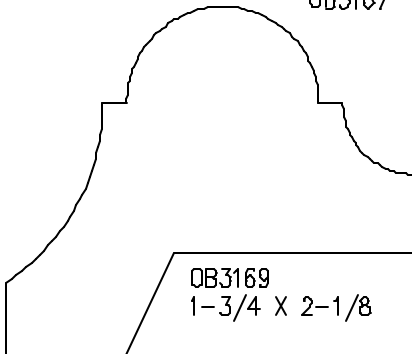

OB3169
1-3/4 X 2-1/8

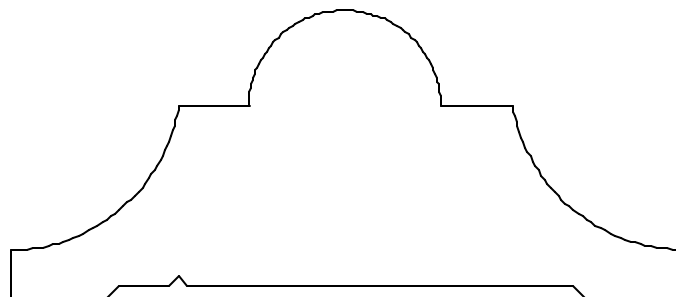

OB3170 1-1/2 X 3-1/2

O.B. WILLIAMS COMPANY

ESTABLISHED 1889

1939 FIRST AVE. SO. SEATTLE, WASHINGTON 98134 (206) 623-2494 FAX 623-2602

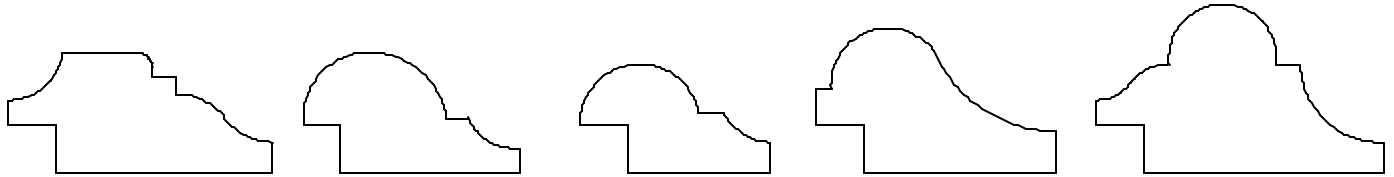

OB3171
5/8 X 1-3/8

OB3172
5/8 X 1-1/8

OB3173
9/16 X 1

OB3174
3/4 X 1-1/4

OB3175
7/8 X 1-1/2

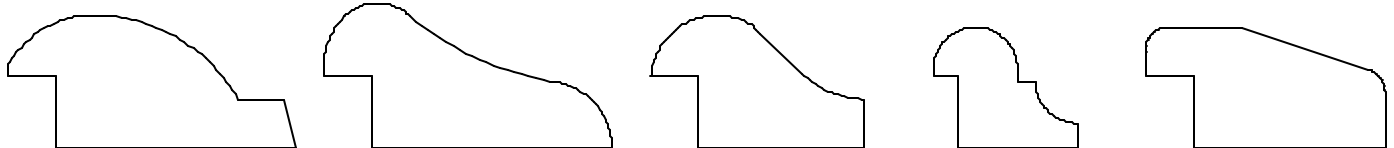

OB3176
11/16 X 1-1/2

OB3177
3/4 X 1-1/2

OB3178
11/16 X 1-1/8

OB3179
5/8 X 3/4

OB3180
5/8 X 1-1/4



OB3181
5/8 X 1-5/8

OB3182
3/4 X 1-7/8

OB3183
11/16 X 1-5/8

OB3184
3/4 X 1-3/8



OB3185
3/4 X 2-3/16

OB3186
3/4 X 1-3/8

OB3187
3/4 X 3/4

OB3188
7/8 X 1-3/4

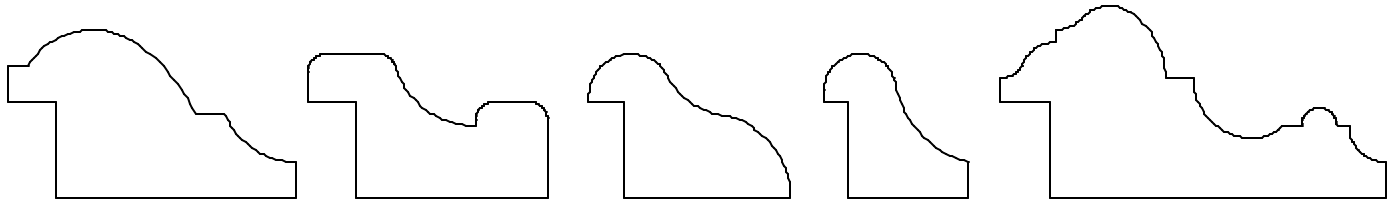

OB3189
7/8 X 1-1/2

OB3190
3/4 X 1-1/4

OB3191
3/4 X 1-1/16

OB3192
3/4 X 3/4

OB3193
1 X 2

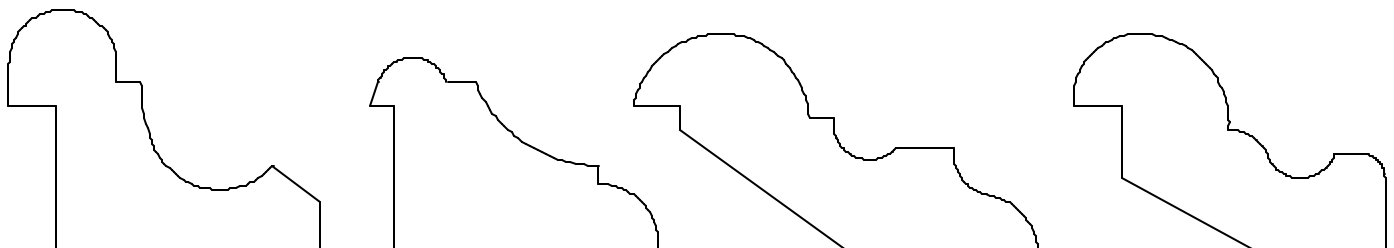

OB3194
1-1/4 X 1-5/8

OB3195
1 X 1-1/2

OB3196
1-1/8 X 2-1/8

OB3197
1-1/8 X 1-5/8

ALL MOULDINGS ARE MADE TO ORDER AND ARE AVAILABLE IN ANY SPECIES OF WOOD.

PICTURE FRAME MOULDINGS

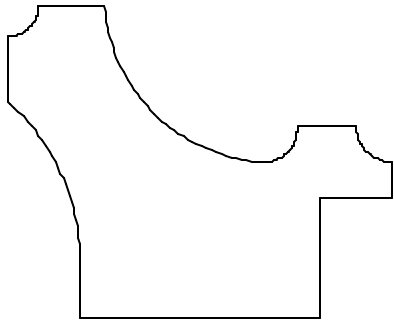

OB3201
1-5/8 X 2

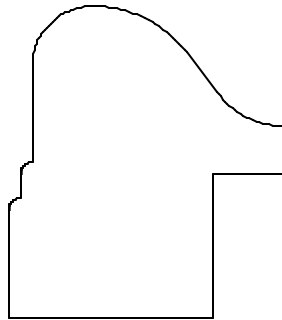

OB3202
1-7/16 X 1-5/8

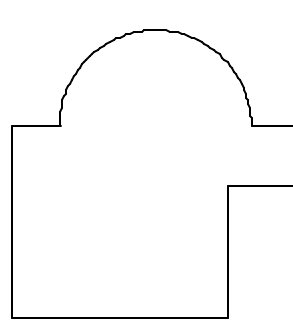

OB3203
1-1/2 X 1-1/2

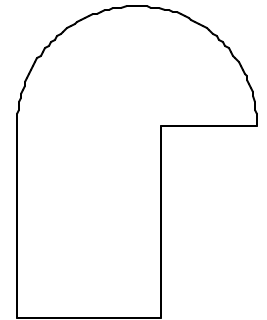

OB3204
1-1/4 X 1-5/8

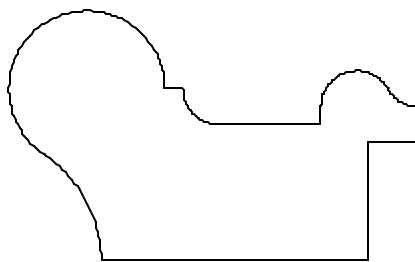

OB3205
1-5/16 X 2-1/8

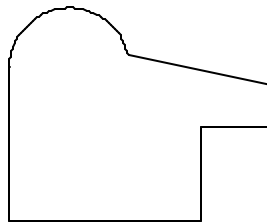

OB3206
1-1/8 X 1-3/8

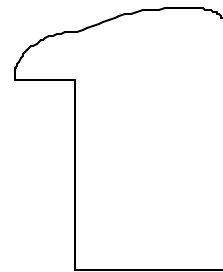

OB3207
1-1/8 X 1-3/8

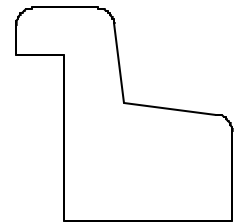

OB3208
1-1/8 X 1-1/8

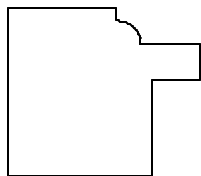

OB3209
7/8 X 1

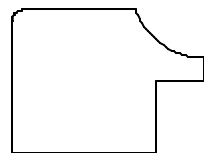

OB3210
3/4 X 1

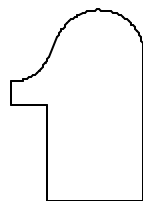

OB3211
11/16 X 1

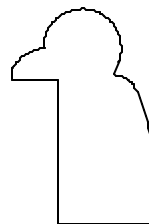

OB3212
3/4 X 1-1/8

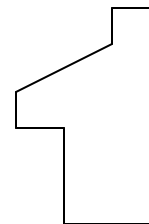

OB3213
3/4 X 1-1/8

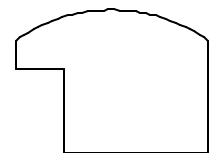

OB3214
3/4 X 1

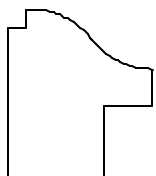

OB3215
3/4 X 7/8

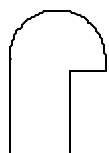

OB3216
1/2 X 3/4

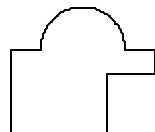

OB3217
11/16 X 3/4

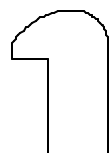

OB3218
1/2 X 3/4



OB3219
3/8 X 3/4

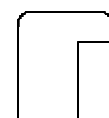

OB3220
1/2 X 9/16



OB3221
3/8 X 5/8



OB3222
5/16 X 7/16

ALL MOULDINGS ARE MADE TO ORDER AND ARE AVAILABLE IN ANY SPECIES OF WOOD.

MISCELLANEOUS MOULDINGS

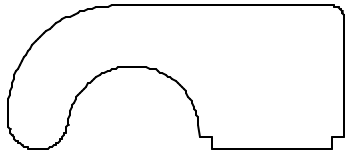

OB3301 3/4 X 1-3/4

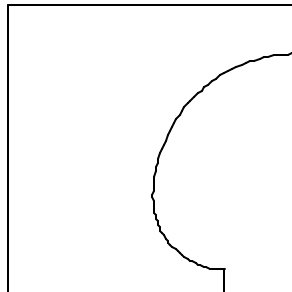

OB3303 1-1/2 X 1-1/2

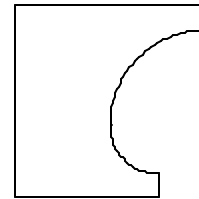

OB3304 1 X 1

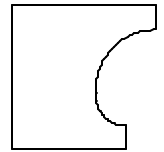

OB3305 3/4 X 3/4



OB3302 1/2 X 1-3/4

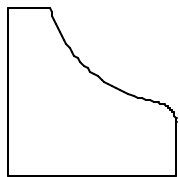

OB3306 7/8 X 7/8

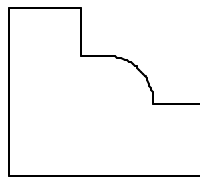

OB3307 7/8 X 1

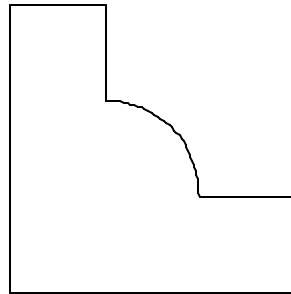

OB3308 1-1/2 X 1-1/2

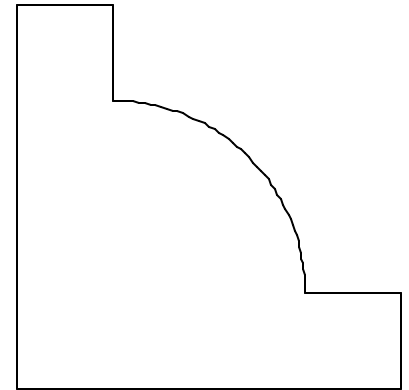

OB3309 2 X 2



OB3310 1/2 X 1-1/4

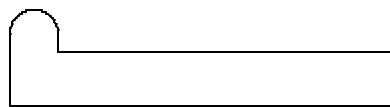

OB3311 1/2 X 2

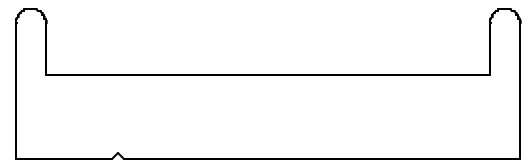

OB3312 3/4 X 2-5/8

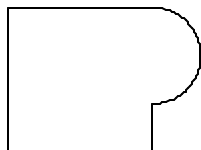

OB3313 3/4 X 1



OB3314 11/16 X 2-1/2



OB3315 1/2 X 2-3/8

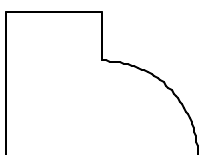

OB3316 3/4 X 1

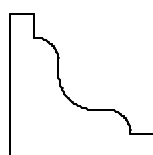

OB3317 3/4 X 3/4

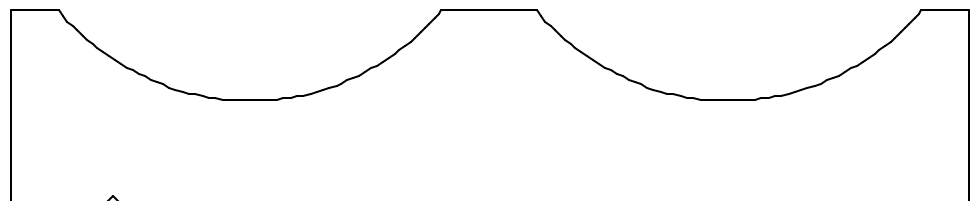

OB3318 1 X 5

ALL MOULDINGS ARE MADE TO ORDER AND ARE AVAILABLE IN ANY SPECIES OF WOOD.

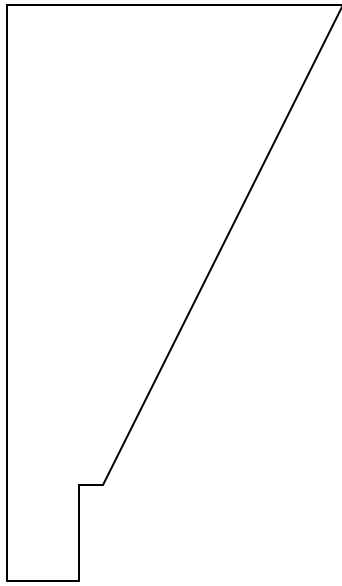

OB3319
1-3/4 X 3

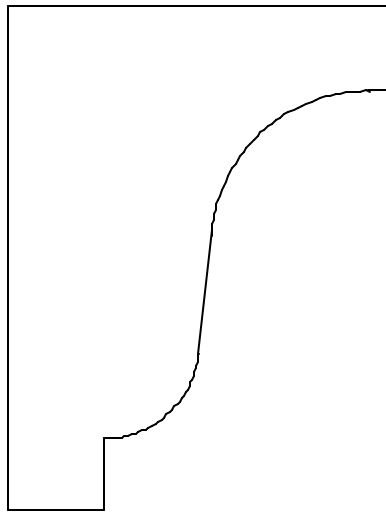

OB3320
2 X 2-5/8

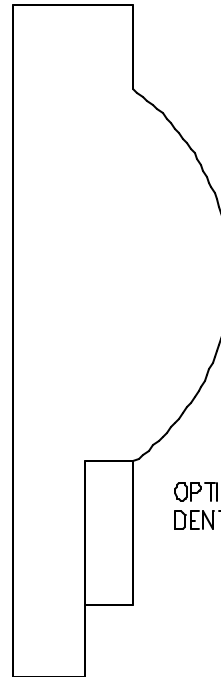

OB3321
1-1/8 X 3-1/2

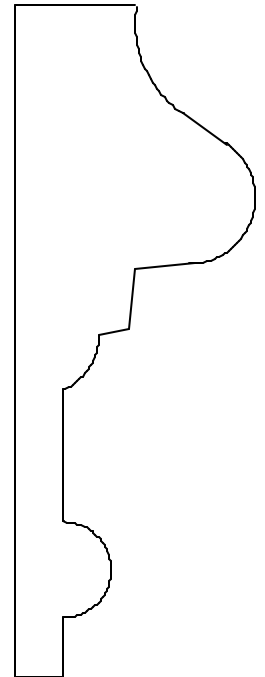

OB3322
1-1/4 X 3-1/2

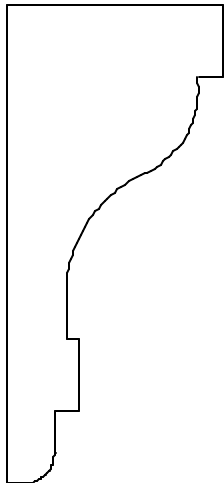

OB3323
1-1/8 X 2-1/2

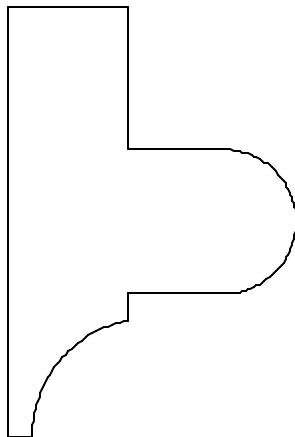

OB3324
1-1/2 X 2-1/4

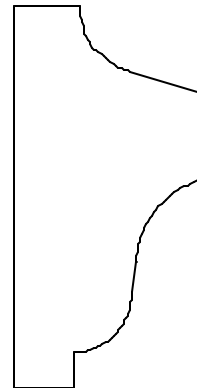

OB3325
1 X 2



OB3326
3/4 X 1-3/4

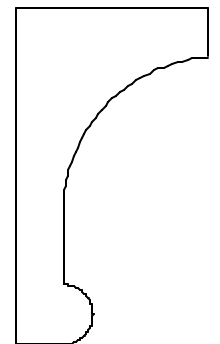

OB3327
1 X 1-3/4

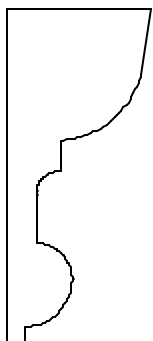

OB3328
3/4 X 1-3/4

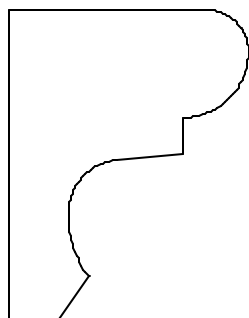

OB3329
1-1/4 X 1-5/8



OB3330
3/4 X 1-1/2



OB3331
5/8 X 1-9/16

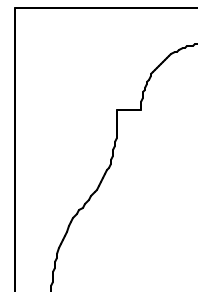

OB3332
1 X 1-1/2

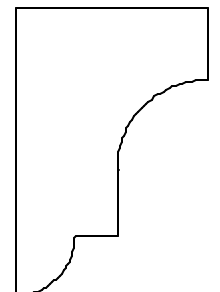

OB3333
1 X 1-1/2

O.B. WILLIAMS COMPANY

ESTABLISHED 1889

1939 FIRST AVE. SO. SEATTLE, WASHINGTON 98134 (206) 623-2494 FAX 623-2602

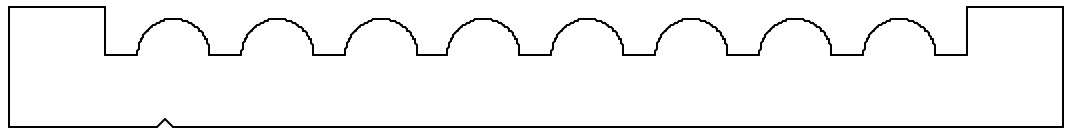

OB3334 5/8 X 5-1/2

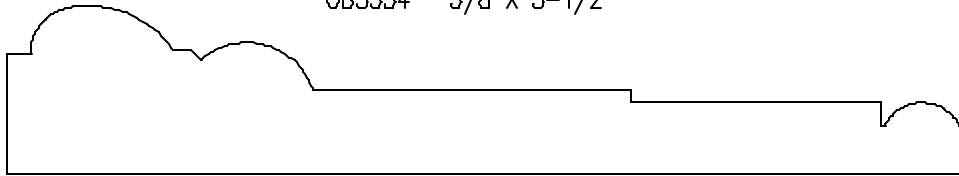

OB3335 7/8 X 5

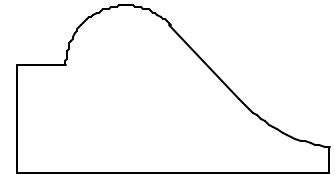

OB3336 7/8 X 1-5/8

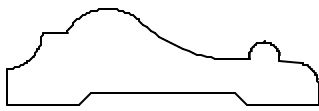

OB3337 1/2 X 1-5/8

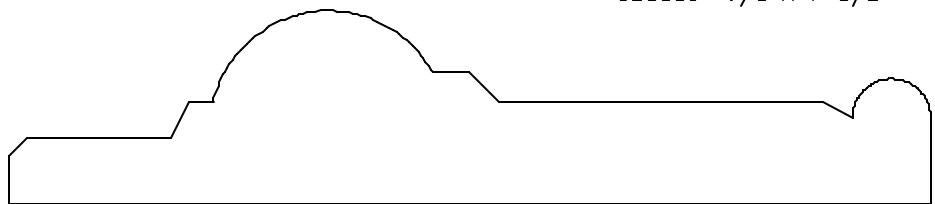

OB3338 1 X 4-13/16

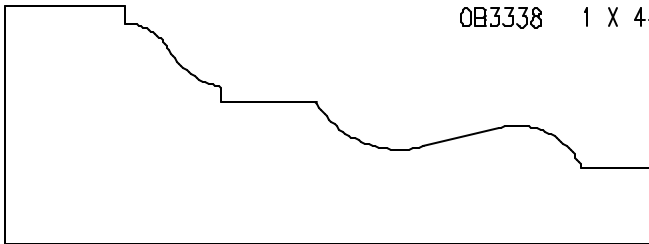

OB3339 1-1/4 X 3-3/8

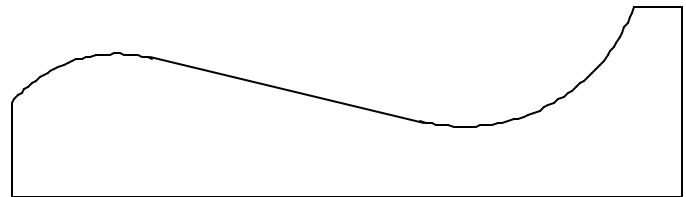

OB3340 1 X 3-1/2

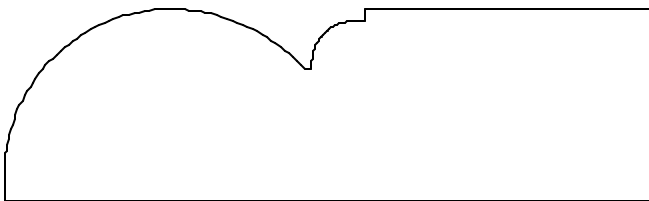

OB3341 1 X 3-3/8

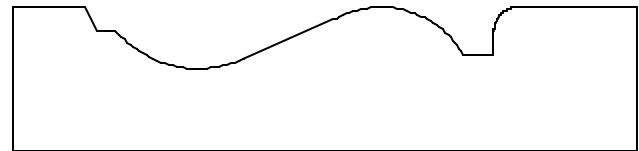

OB3342 3/4 X 3-1/4

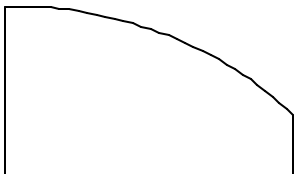

OB3343 7/8 X 1-1/2

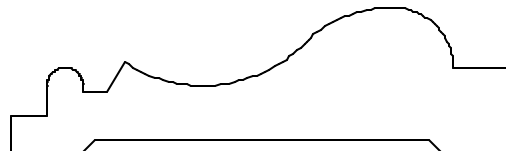

OB3344 3/4 X 2-5/8

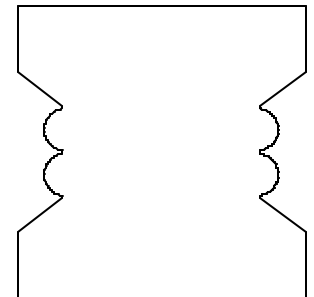

OB3348 1-1/2 X 1-1/2

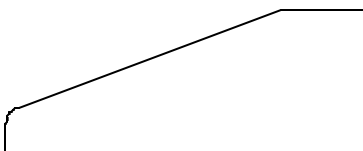

OB3345 3/4 X 1-7/8

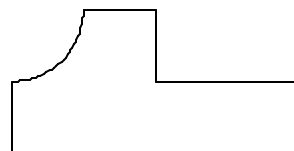

OB3346 3/4 X 1-1/2

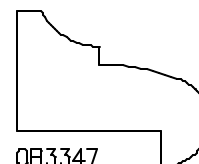

OB3347
13/16 X 1

ALL MOULDINGS ARE MADE TO ORDER AND ARE AVAILABLE IN ANY SPECIES OF WOOD.

O.B. WILLIAMS COMPANY

ESTABLISHED 1889

1939 FIRST AVE. SO. SEATTLE, WASHINGTON 98134 (206) 623-2494 FAX 623-2602

WALL CAP

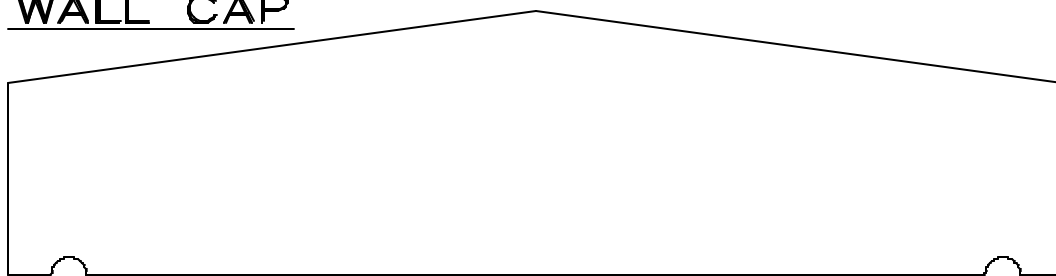

OB3349 1-3/8 X 5-1/2

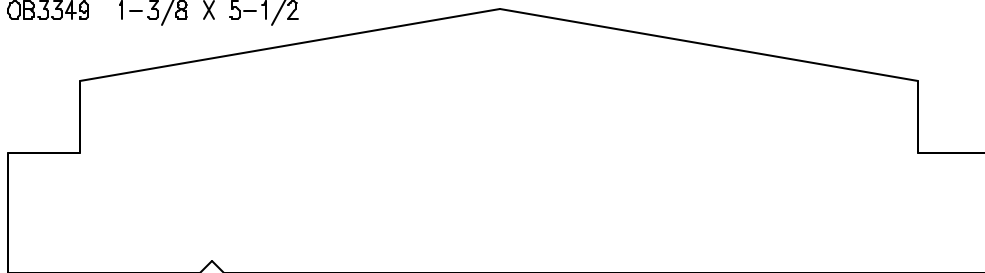

OB3350 1-3/8 X 5-1/8

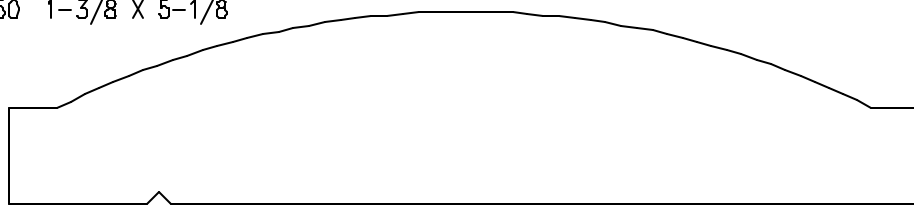

OB3353 1- X 4-3/4

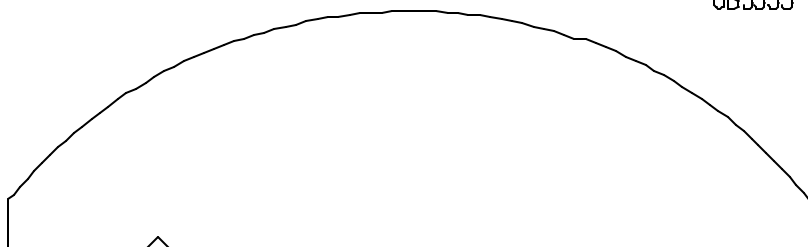

OB3354 1-1/4 X 4-3/16

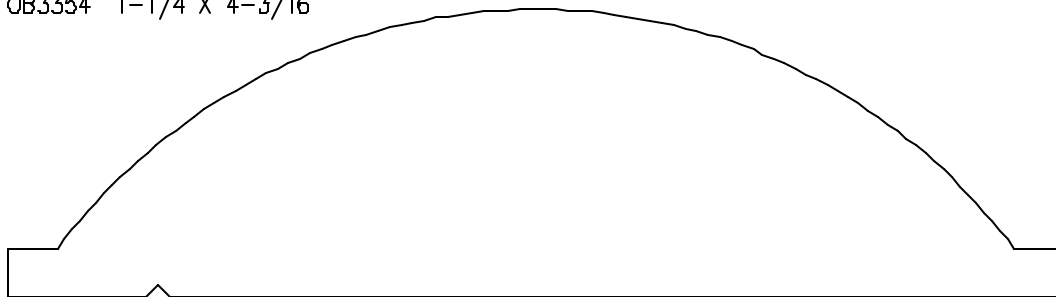

OB3351 1-1/2 X 5-1/2

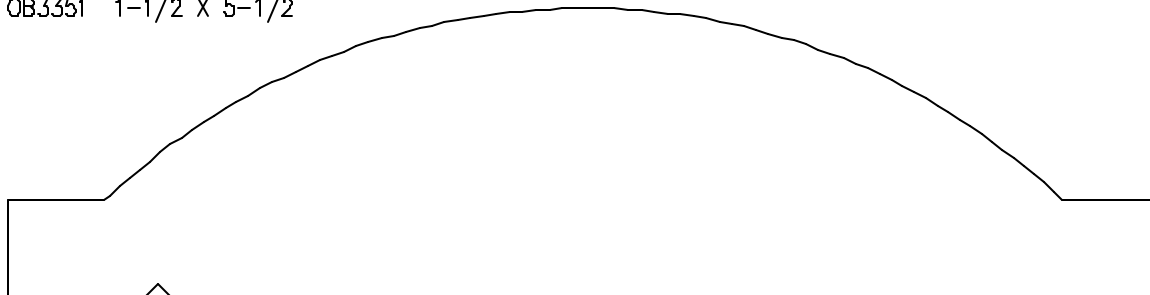

OB3352 1-1/2 X 6

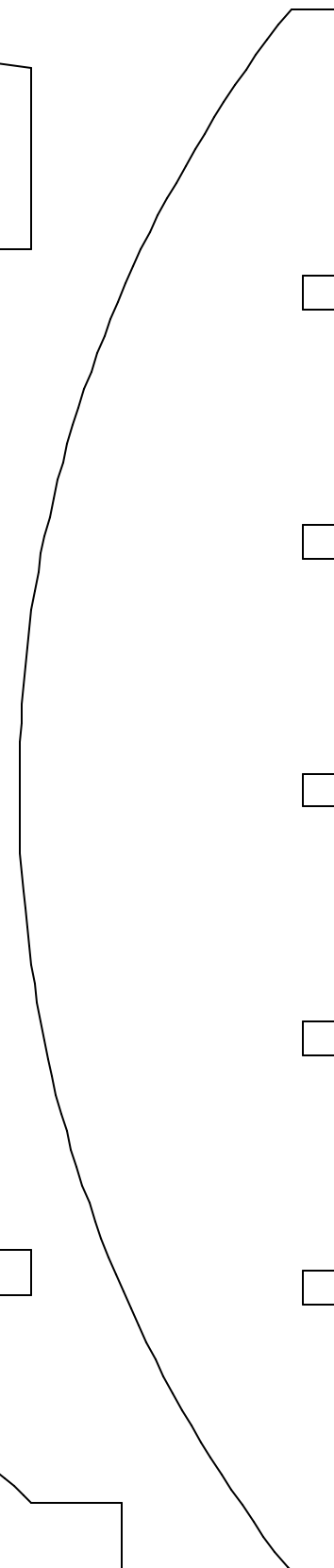

OB3355
1-3/4 X 8-5/8

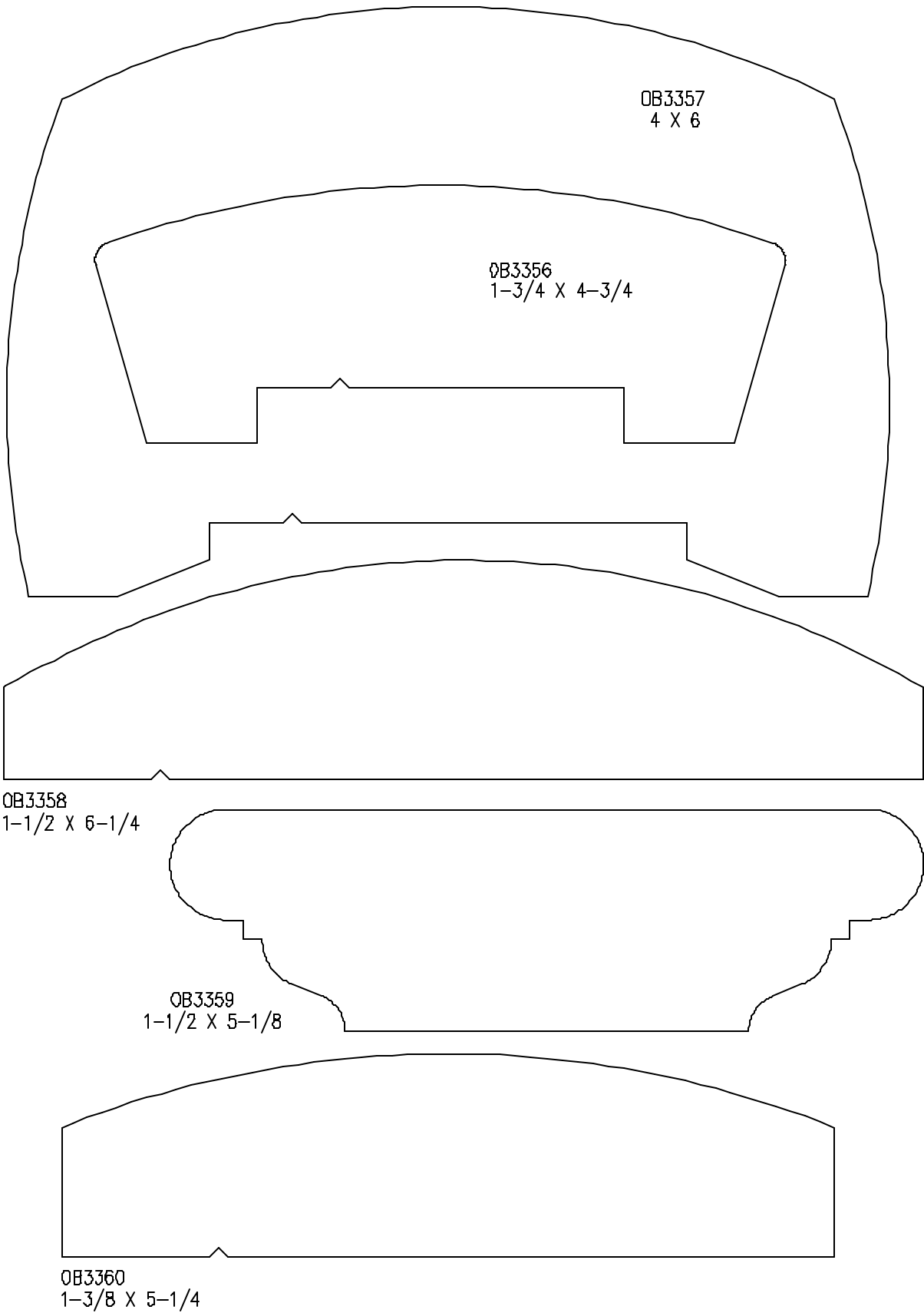

O.B. WILLIAMS COMPANY

ESTABLISHED 1889

1939 FIRST AVE. SO. SEATTLE, WASHINGTON 98134 (206) 623-2494 FAX 623-2602

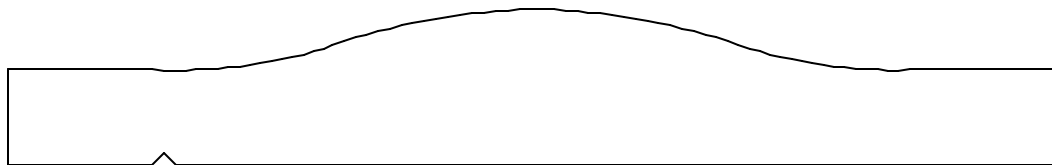

OB3361 1-3/16 X 5-1/2

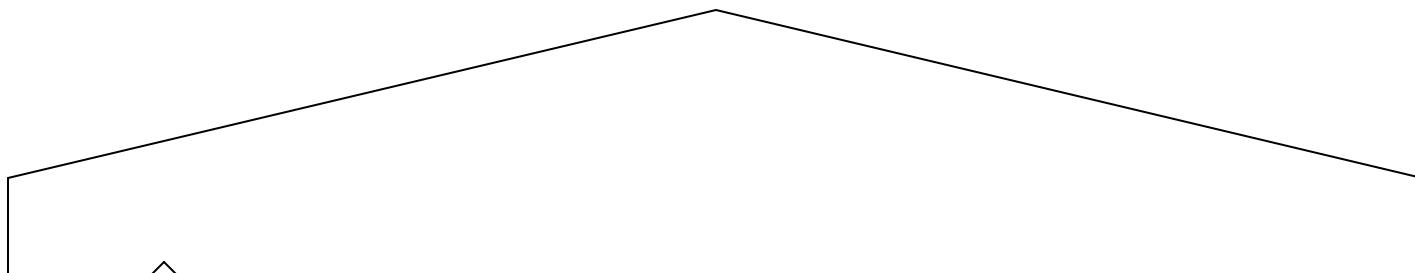

OB3362 1-3/8 X 7-3/8

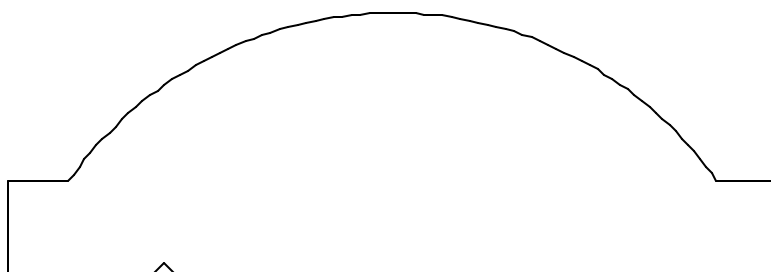

OB3363 1-3/8 X 4

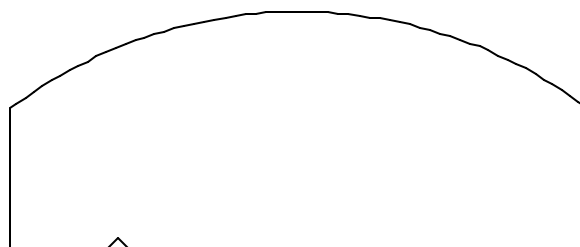

OB3364 1-1/4 X 3

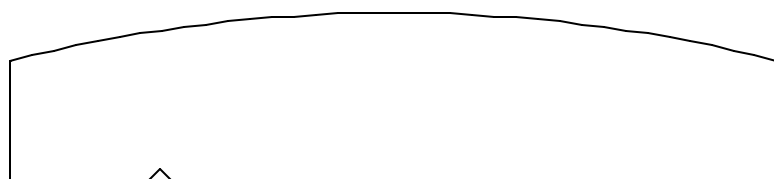

OB3365 7/8 X 4

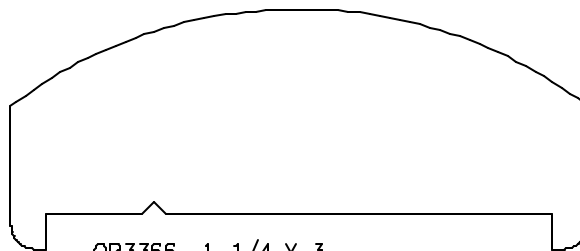

OB3366 1-1/4 X 3

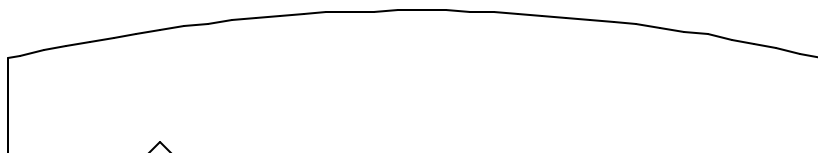

OB3367 3/4 X 4-1/4

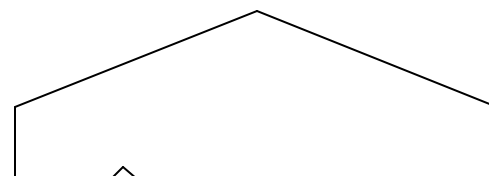

OB3368 7/8 X 2-1/2

ALL MOULDINGS ARE MADE TO ORDER AND ARE AVAILABLE IN ANY SPECIES OF WOOD.

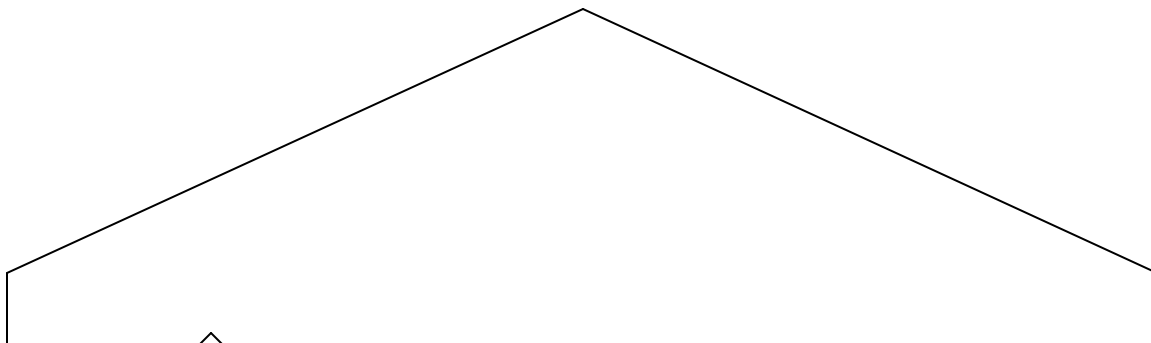

OB3369
1-3/4 X 6

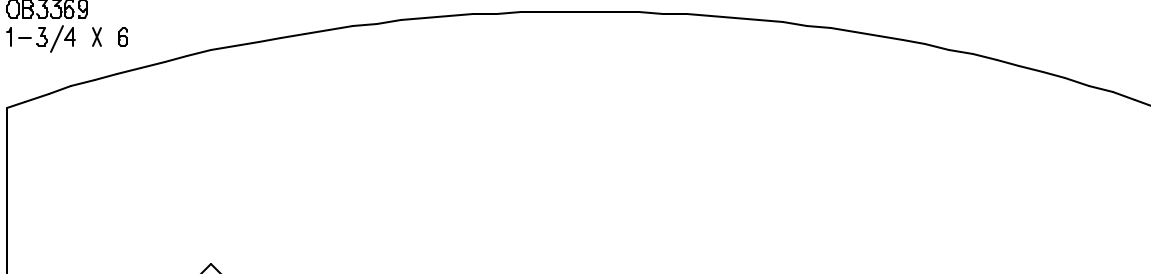

OB3370
1-3/8 X 6

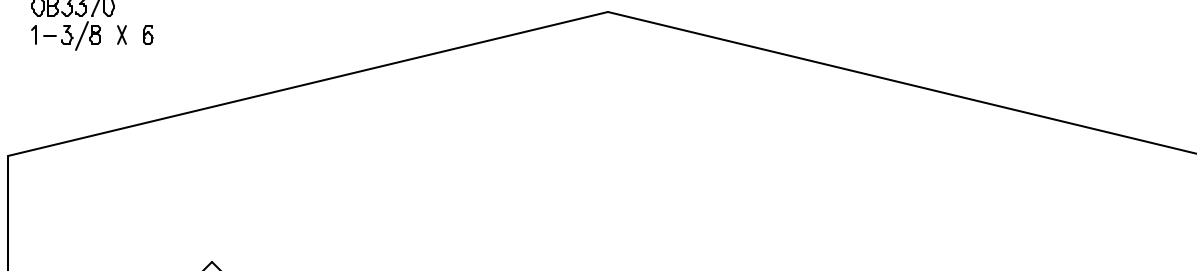

OB3371
1-3/8 X 6-1/4

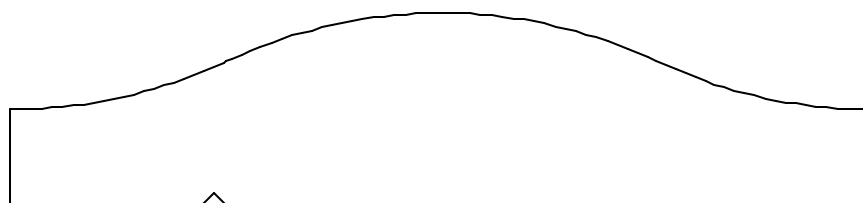

OB3372
1 X 4-1/2

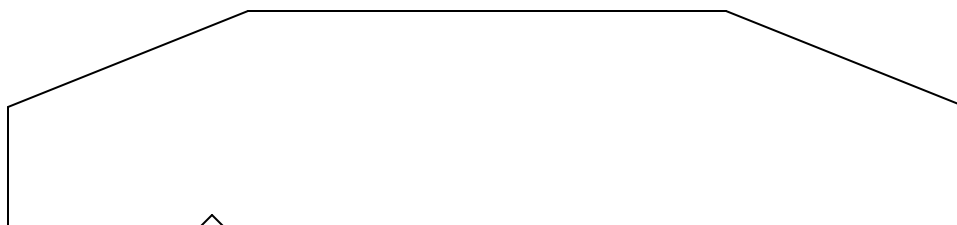

OB3373
1-1/8 X 5

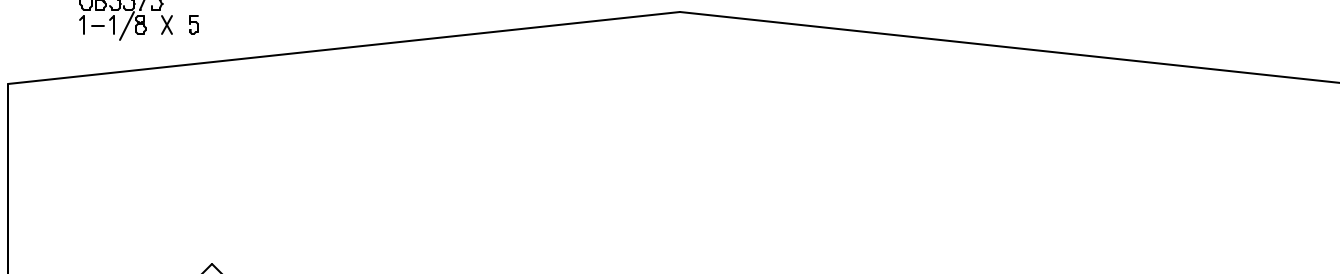

OB3374 1-3/8 X 7

SYMMETRICAL CASING

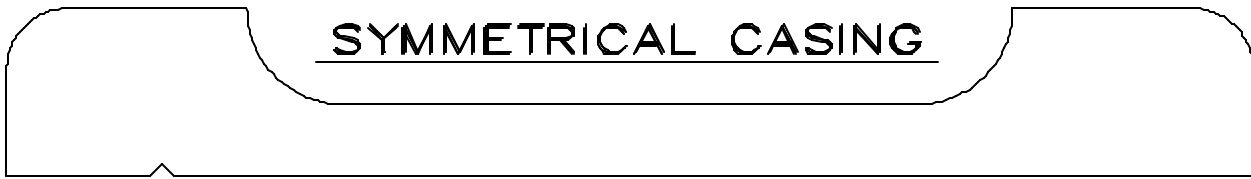

OB3401 7/8 X 6-1/2

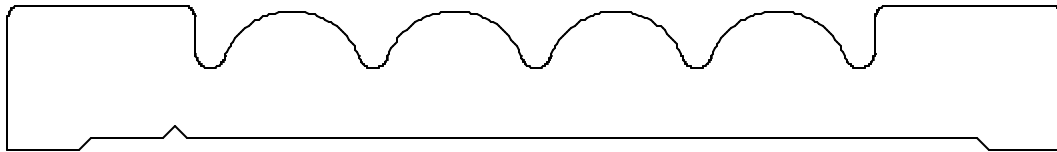

OB3402 3/4 X 5-1/2



OB3403 3/4 X 5-5/8



OB3404 3/4 X 5-1/2

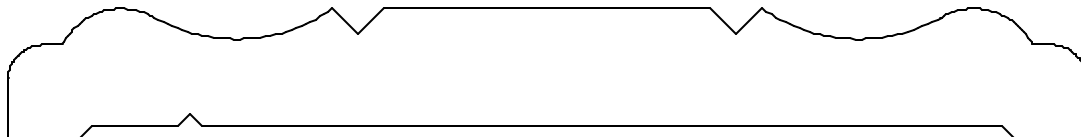

OB3405 11/16 X 5-5/8

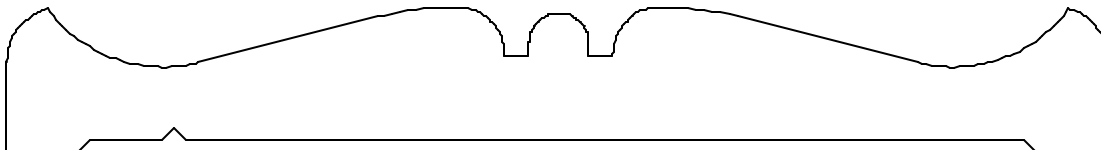

OB3406 3/4 X 5-3/4



OB3407 3/4 X 5-1/4

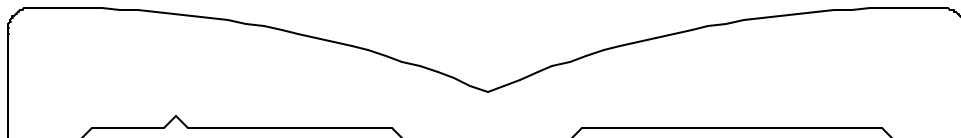

OB3408 3/4 X 5

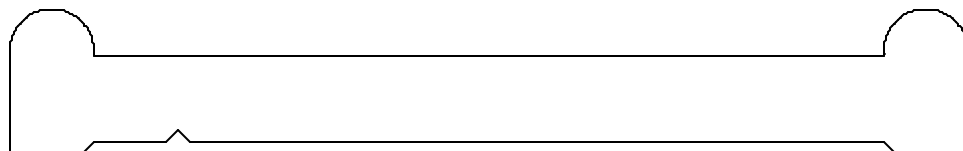

OB3409 3/4 X 5

O.B. WILLIAMS COMPANY

ESTABLISHED 1889

1939 FIRST AVE. SO. SEATTLE, WASHINGTON 98134 (206) 623-2494 FAX 623-2602

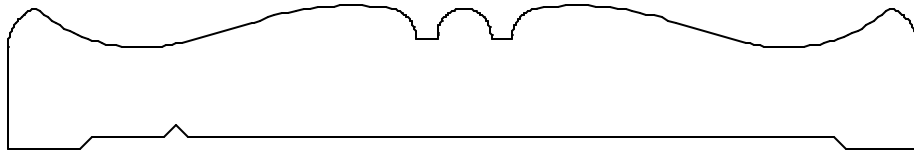

OB3410 3/4 X 4-3/4



OB3412 3/4 X 4-1/2

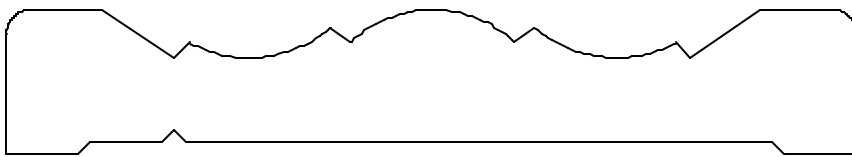

OB3414 3/4 X 4-1/2

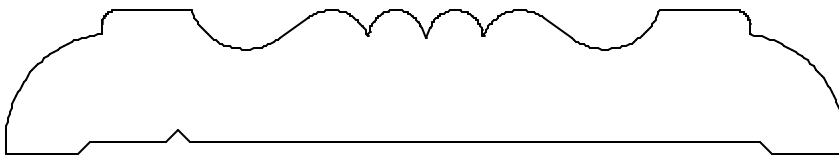

OB3416 3/4 X 4-3/8

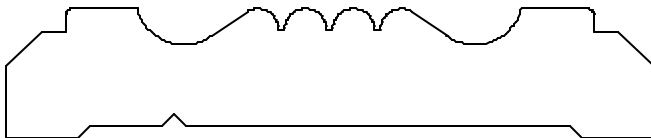

OB3418 11/16 X 3-3/8

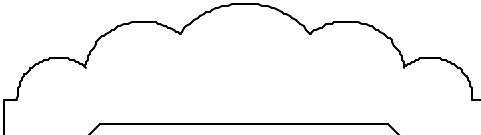

OB3420 11/16 X 2-1/2

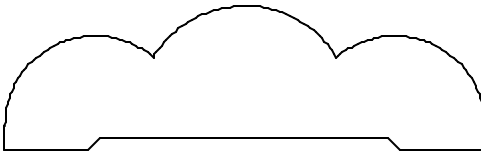

OB3422 3/4 X 2-1/2

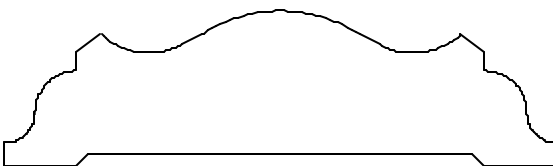

OB3424 13/16 X 2-7/8



OB3426 11/16 X 2-1/2

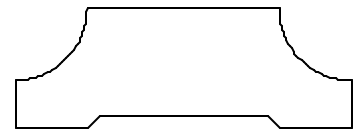

OB3411 5/8 X 1-3/4



OB3413 3/4 X 2

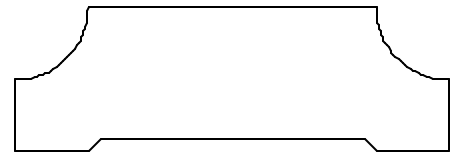

OB3415 3/4 X 2-1/4



OB3417 3/4 X 1-3/4

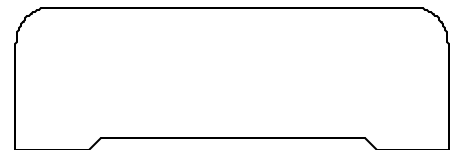

OB3419 3/4 X 2-1/4

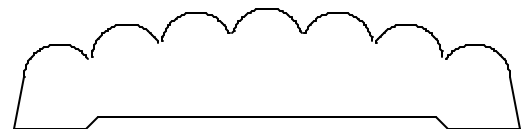

OB3421 5/8 X 2-5/8



OB3423 5/8 X 3

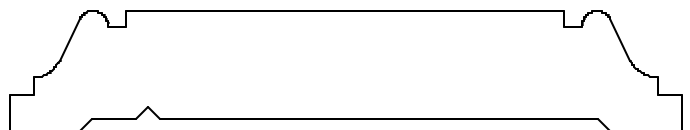

OB3425 5/8 X 3-1/2

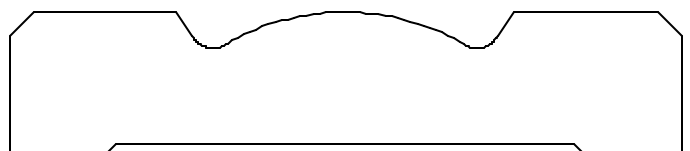

OB3427 3/4 X 3-1/2

O.B. WILLIAMS COMPANY

ESTABLISHED 1889

1939 FIRST AVE. SO. SEATTLE, WASHINGTON 98134 (206) 623-2494 FAX 623-2602

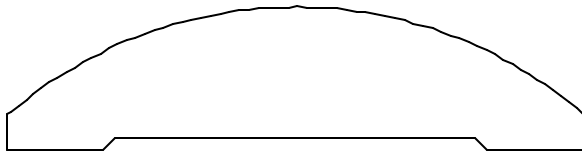

OB3441 3/4 X 3

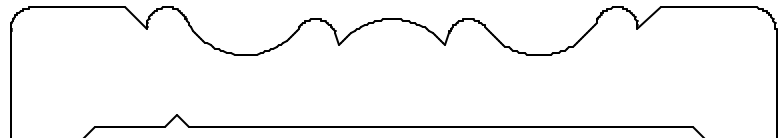

OB3450 1 1/16 X 4

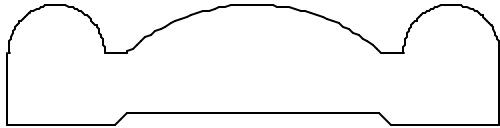

OB3442 5/8 X 2-9/16

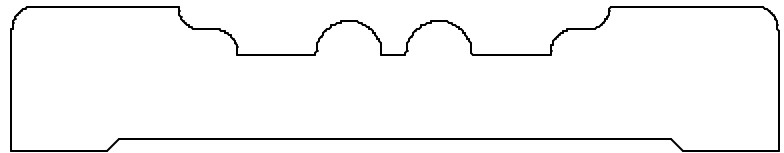

OB3451 3/4 X 4

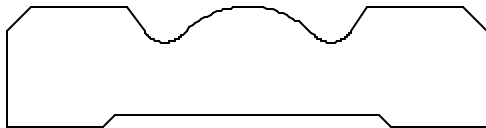

OB3443 5/8 X 2-1/2

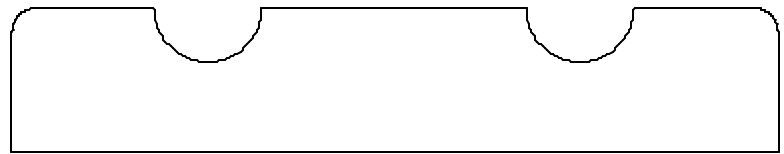

OB3452 3/4 X 4

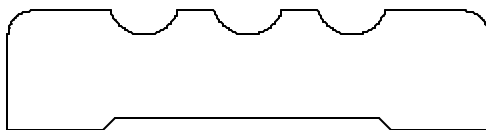

OB3444 5/8 X 2-1/2

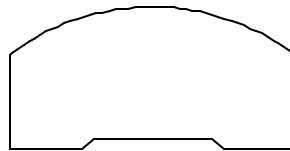

OB3453 3/4 X 1-1/2



OB3454 5/8 X 1-5/8

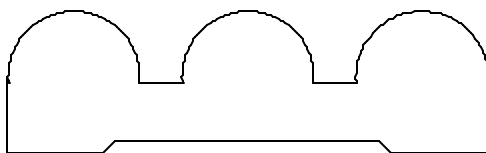

OB3445 3/4 X 2-1/2



OB3446 5/8 X 2-1/2



OB3455 5/8 X 2

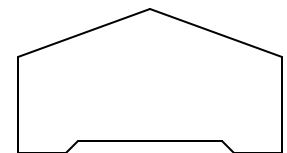

OB3456 3/4 X 1-3/8



OB3447 5/8 X 2

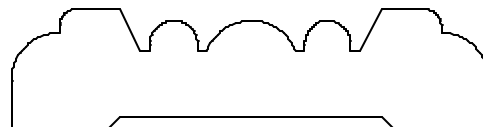

OB3457 5/8 X 2-1/2



OB3458 5/8 X 2-1/8

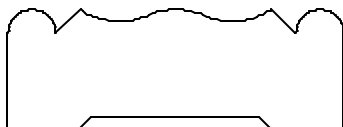

OB3448 5/8 X 1-3/4



OB3459 5/8 X 3-1/2

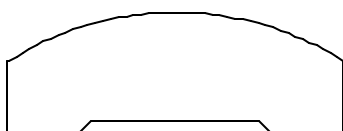

OB3449 5/8 X 1-3/4



OB3460 5/8 X 1-7/8



OB3461 1/2 X 1-5/8

ALL MOULDINGS ARE MADE TO ORDER AND ARE AVAILABLE IN ANY SPECIES OF WOOD.

O.B. WILLIAMS COMPANY

ESTABLISHED 1889

1939 FIRST AVE. SO. SEATTLE, WASHINGTON 98134 (206) 623-2494 FAX 623-2602

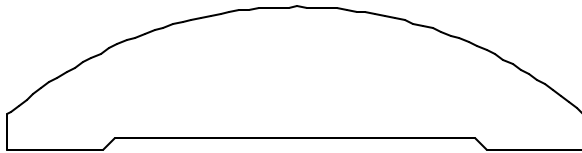

OB3441 3/4 X 3

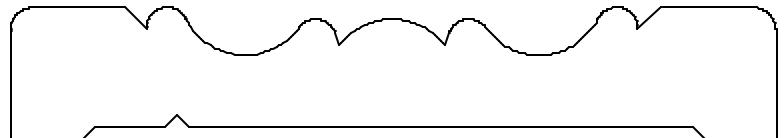

OB3450 1 1/16 X 4

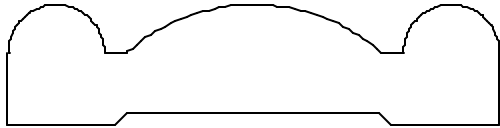

OB3442 5/8 X 2-9/16

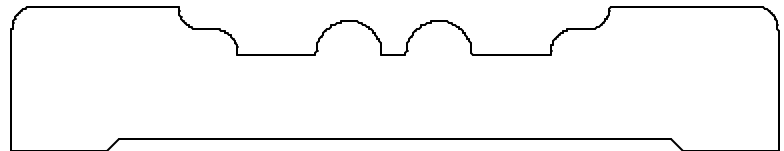

OB3451 3/4 X 4



OB3443 5/8 X 2-1/2

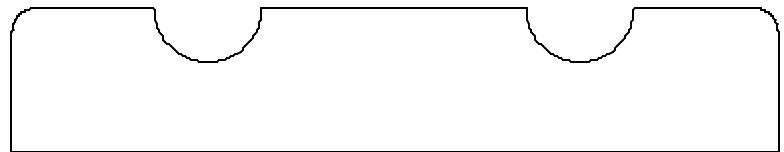

OB3452 3/4 X 4

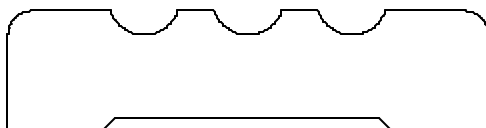

OB3444 5/8 X 2-1/2

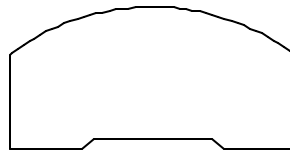

OB3453 3/4 X 1-1/2



OB3454 5/8 X 1-5/8

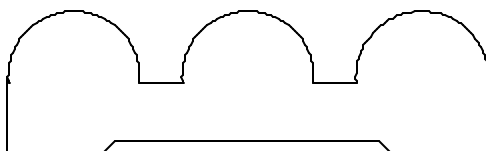

OB3445 3/4 X 2-1/2



OB3446 5/8 X 2-1/2



OB3455 5/8 X 2

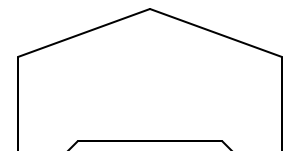

OB3456 3/4 X 1-3/8

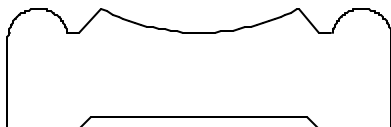

OB3447 5/8 X 2

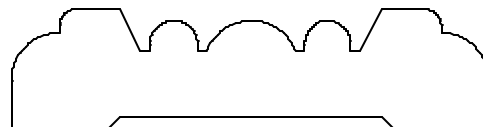

OB3457 5/8 X 2-1/2

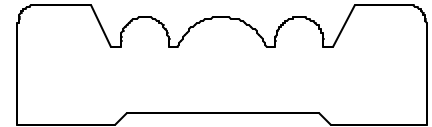

OB3458 5/8 X 2-1/8

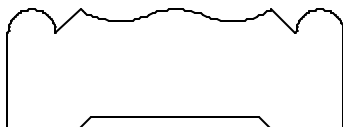

OB3448 5/8 X 1-3/4



OB3459 5/8 X 3-1/2

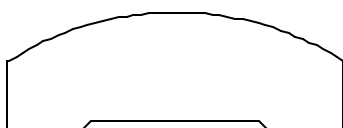

OB3449 5/8 X 1-3/4

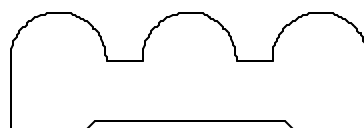

OB3460 5/8 X 1-7/8



OB3461 1/2 X 1-5/8

ALL MOULDINGS ARE MADE TO ORDER AND ARE AVAILABLE IN ANY SPECIES OF WOOD.

APRONS

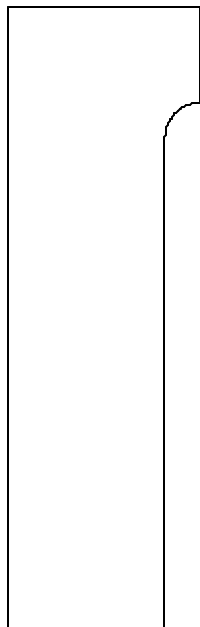

OB3501
1 X 3-1/4

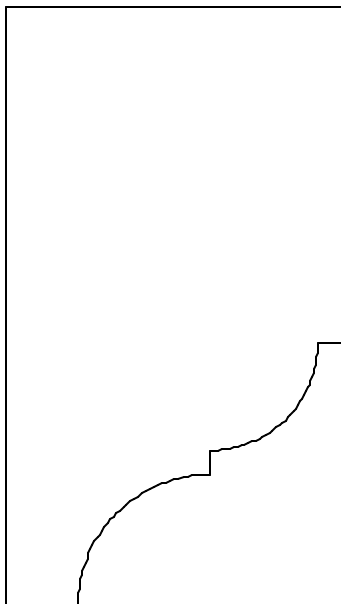

OB3502
1-3/4 X 3-1/8

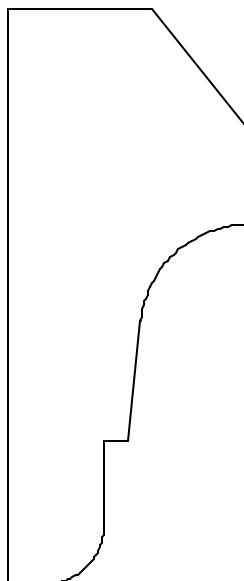

OB3503
1-1/4 X 3

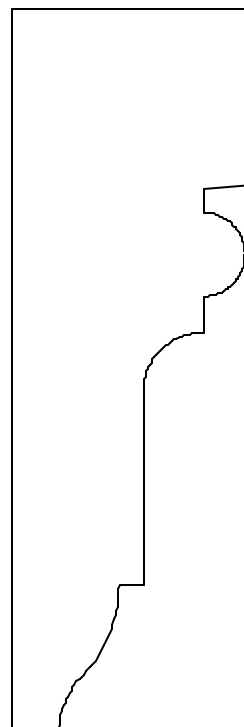

OB3504
1-1/4 X 3-3/4

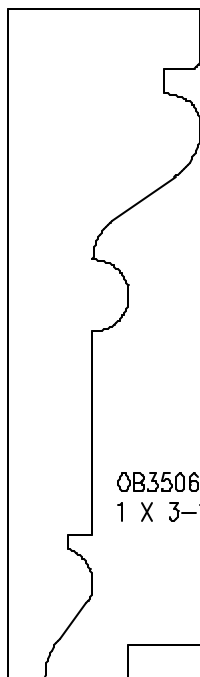

OB3506
1 X 3-1/2

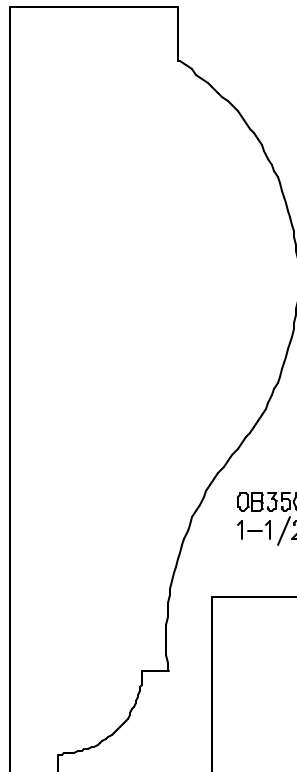

OB3507
1-1/2 X 4

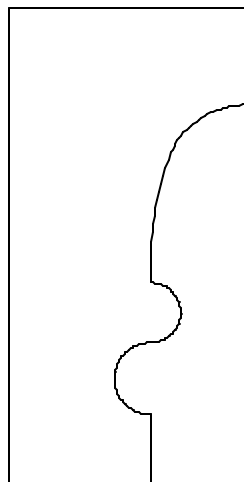

OB3508
1-1/4 X 2-1/2

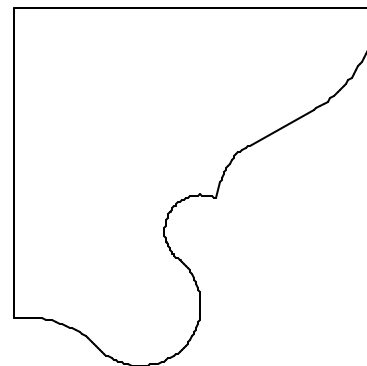

OB3509
1-7/8 X 1-7/8



OB3510
11/16 X 1-1/4

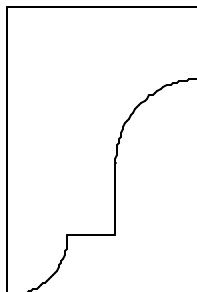

OB3511
1 X 1-1/2



OB3512
1-1/8 X 2-3/8

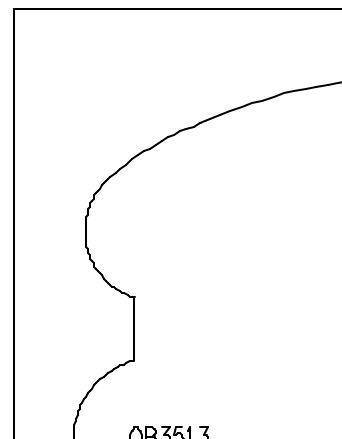

OB3513
1-3/4 X 2-1/4

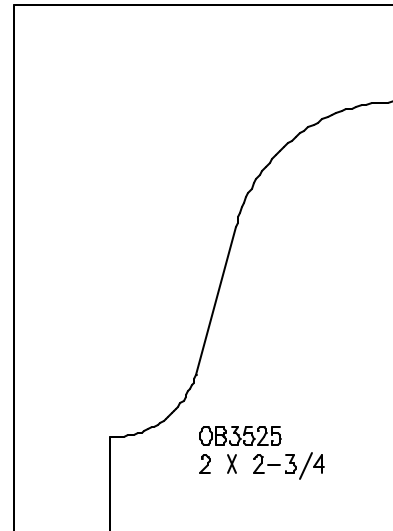
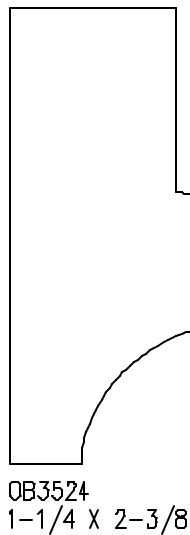
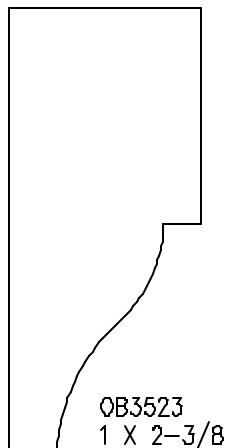
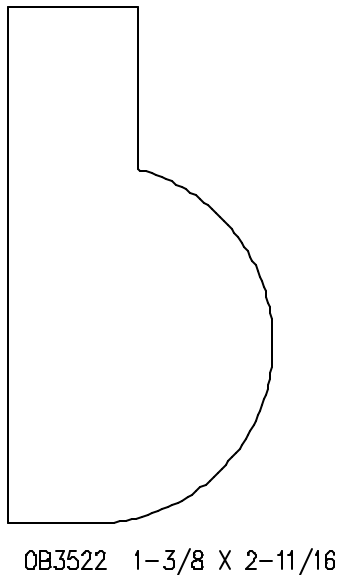
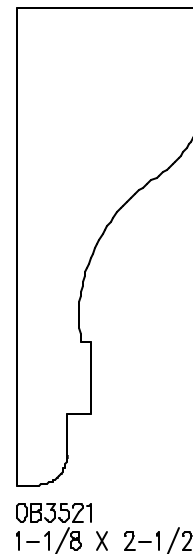
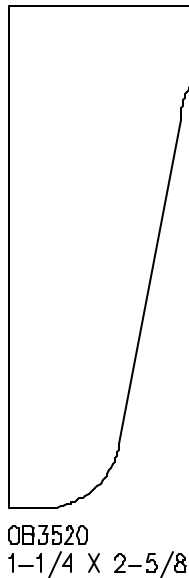
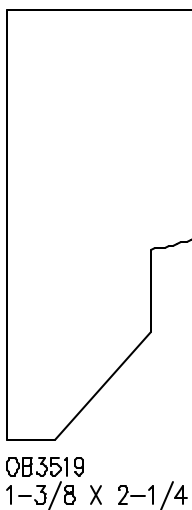
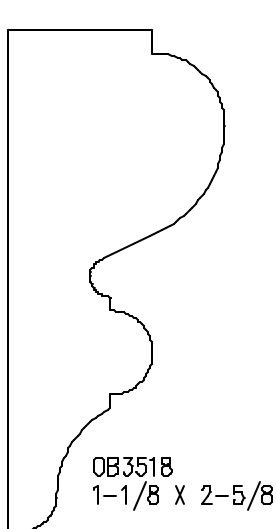
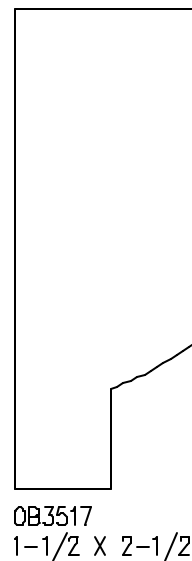
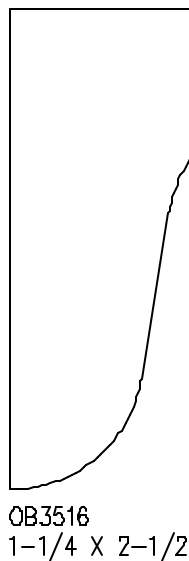
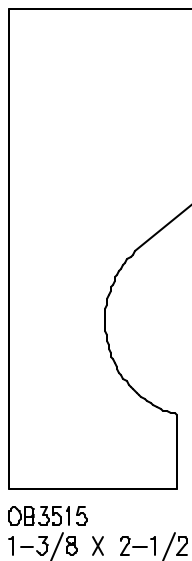
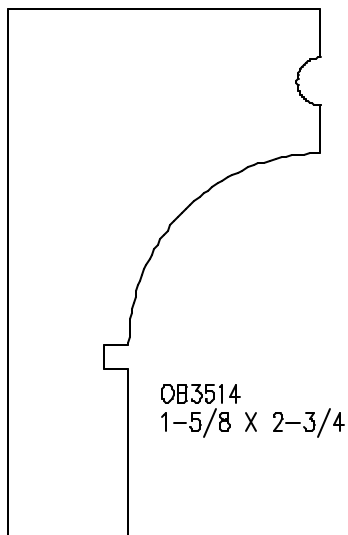

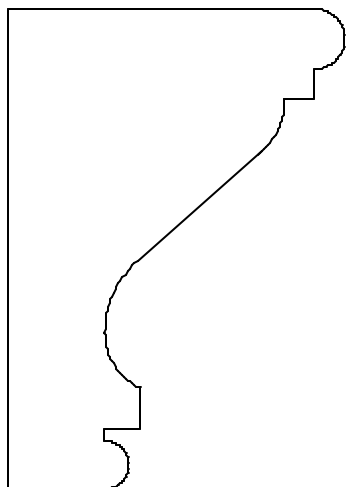

OB3526
1-3/4 X 2-1/2

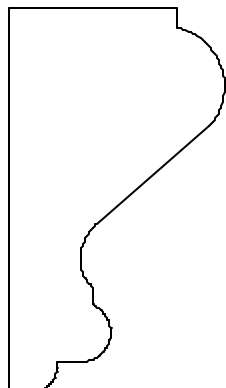

OB3527
1-1/8 X 2

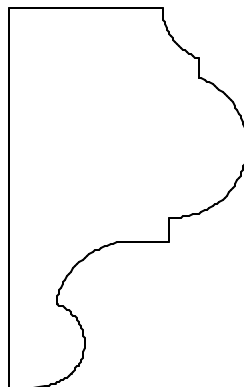

OB3528
1-1/4 X 2

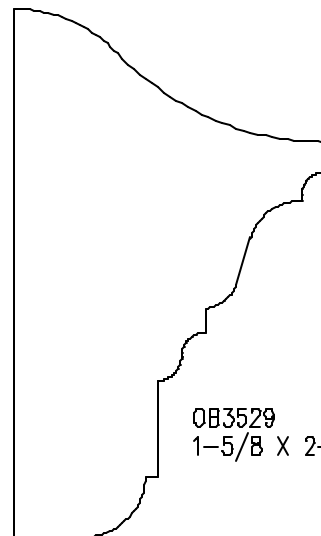

OB3529
1-5/8 X 2-3/4

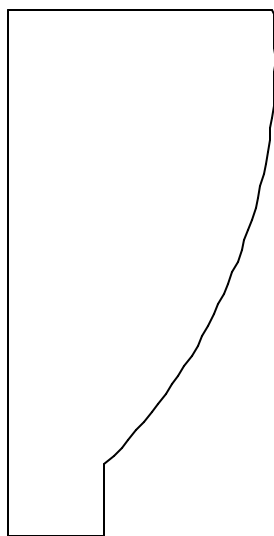

OB3530
1-3/8 X 2-3/4

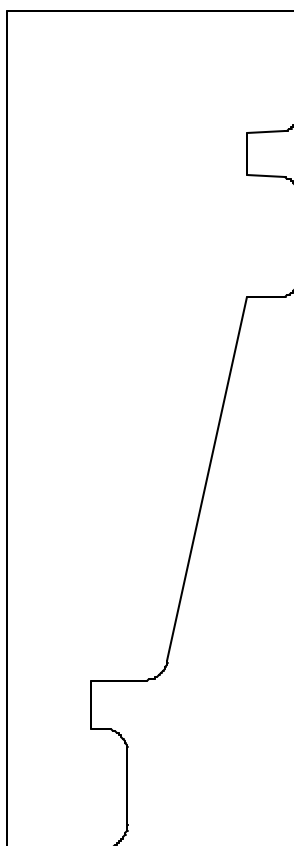

OB3531
1-1/2 X 4-3/8

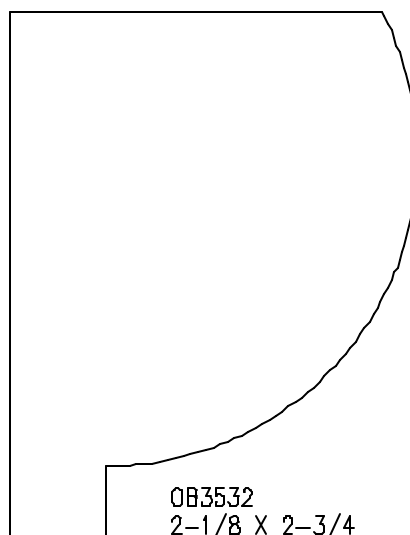

OB3532
2-1/8 X 2-3/4

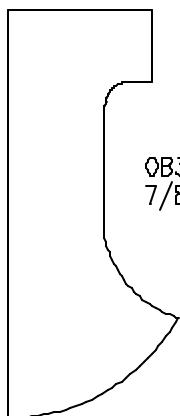

OB3533
7/8 X 2-1/8

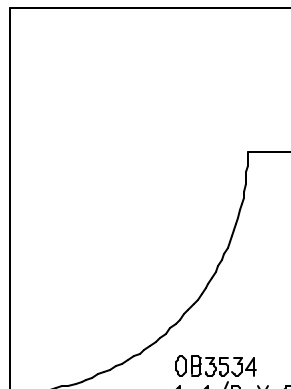

OB3534
1-1/2 X 2

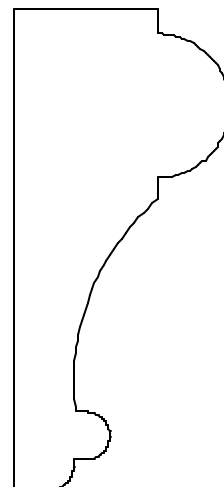

OB3535
1-1/8 X 2-1/2

ALL MOULDINGS ARE MADE TO ORDER AND ARE AVAILABLE IN ANY SPECIES OF WOOD.

O.B. WILLIAMS COMPANY

ESTABLISHED 1889

1939 FIRST AVE. SO. SEATTLE, WASHINGTON 98134 (206) 623-2494 FAX 623-2602

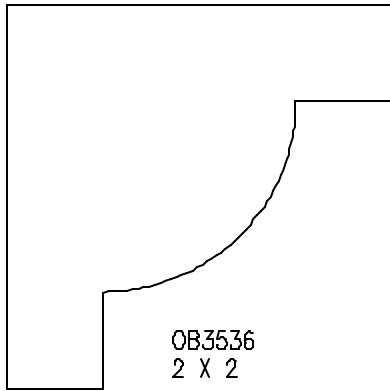

OB3536
2 X 2

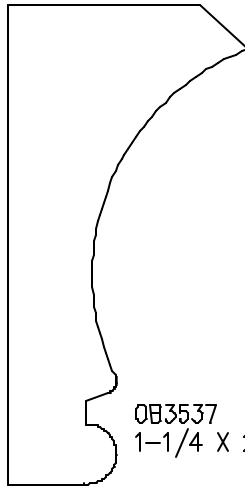

OB3537
1-1/4 X 2-1/2

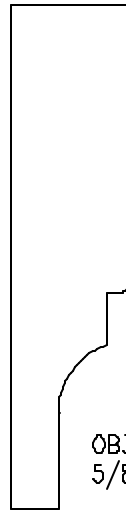

OB3538
5/8 X 2-5/8

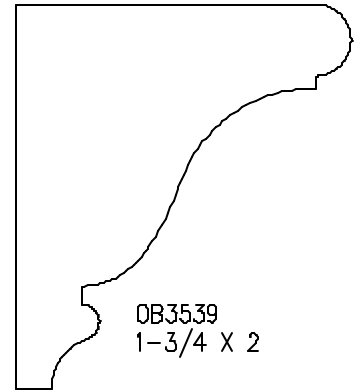

OB3539
1-3/4 X 2

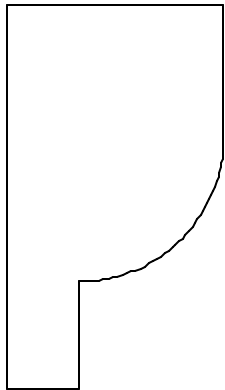

OB3540
1-1/8 X 2



OB3541
3/4 X 2

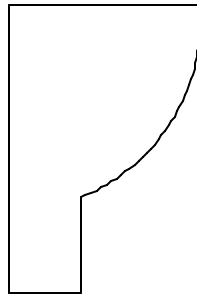

OB3542
1 X 1-1/2

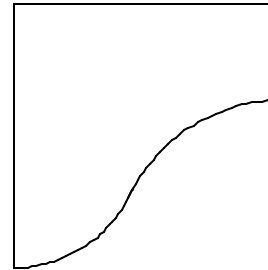

OB3543
1-3/8 X 1-3/8

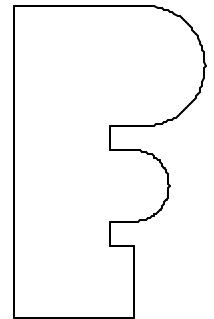

OB3544
1 X 1-5/8

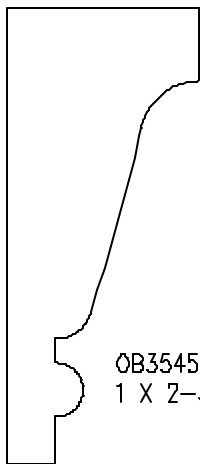

OB3545
1 X 2-3/8

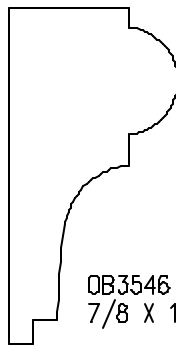

OB3546
7/8 X 1-3/4

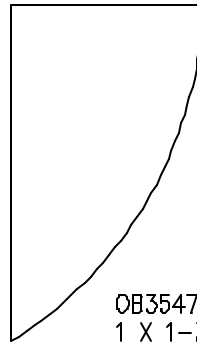

OB3547
1 X 1-3/4



OB3548
3/4 X 1-3/4

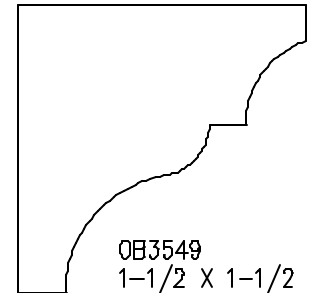

OB3549
1-1/2 X 1-1/2

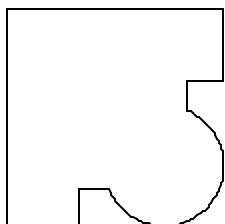

OB3550
1-1/8 X 1-1/8

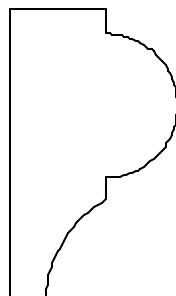

OB3551
7/8 X 1-1/2

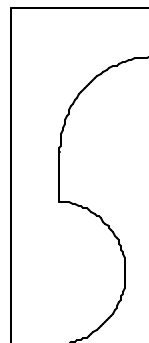

OB3552
3/4 X 1-3/4



OB3553
3/4 X 1-7/8

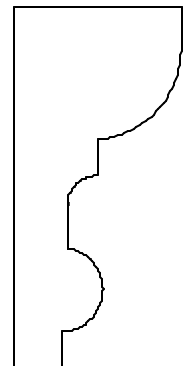

OB3554
7/8 X 1-7/8

ALL MOULDINGS ARE MADE TO ORDER AND ARE AVAILABLE IN ANY SPECIES OF WOOD.

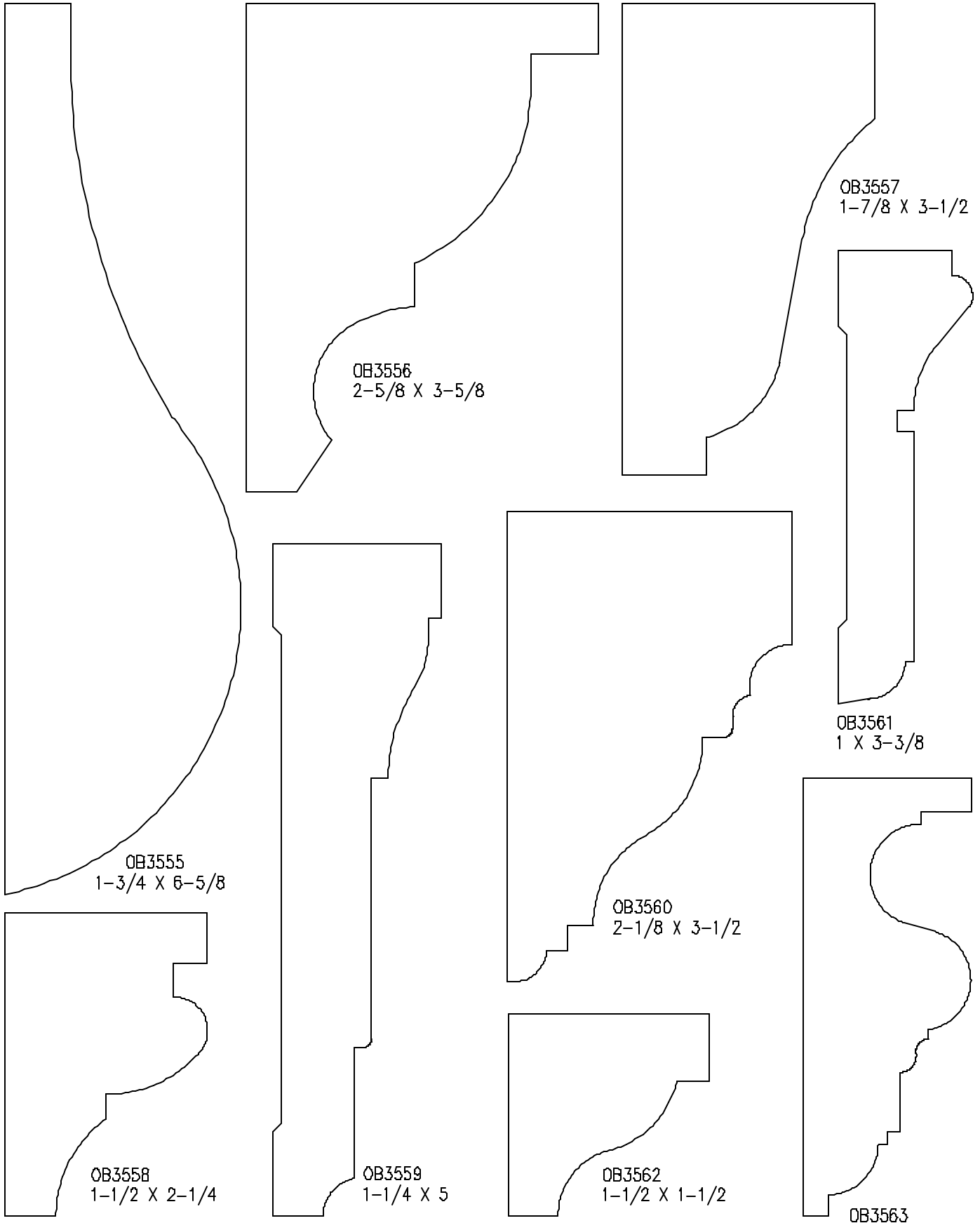

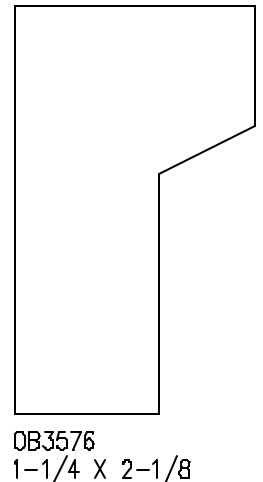
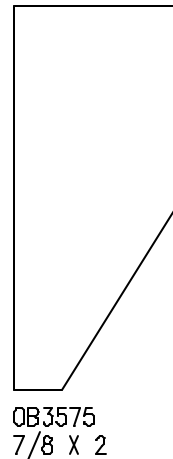
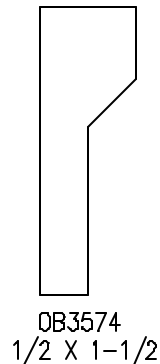
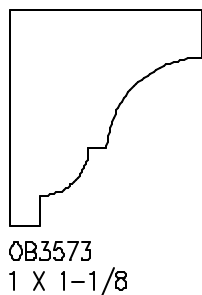
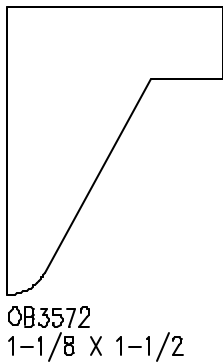
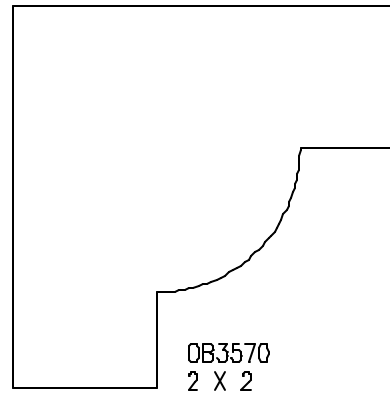
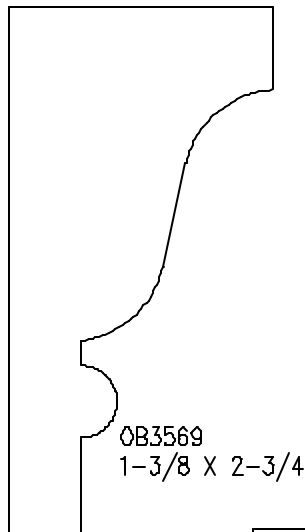
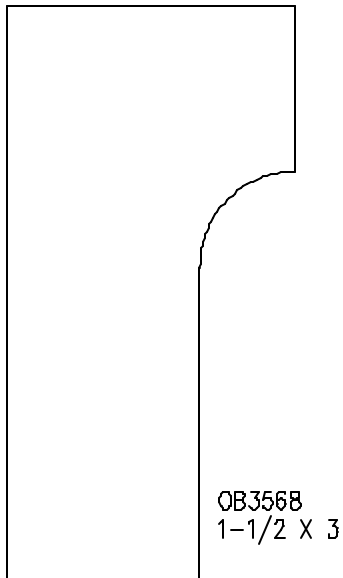
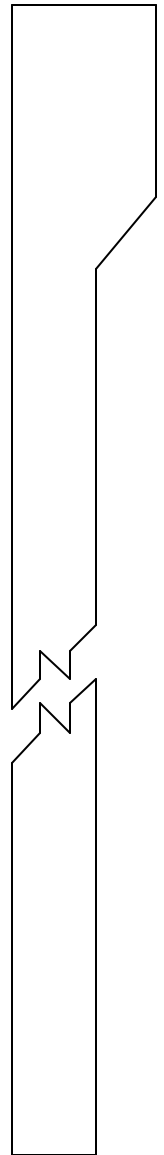
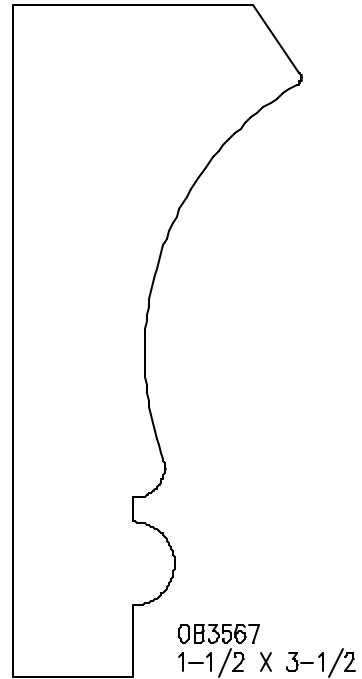
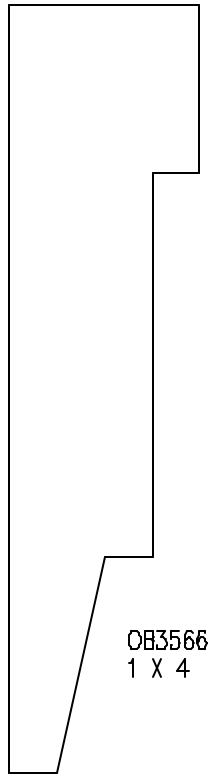
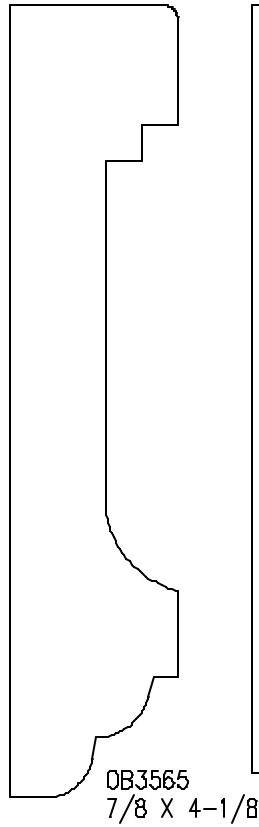
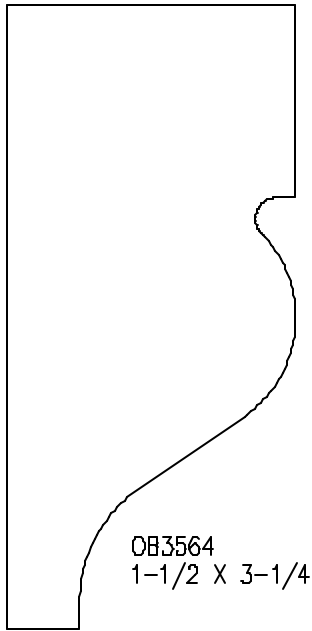

ALL MOULDINGS ARE MADE TO ORDER AND ARE AVAILABLE IN ANY SPECIES OF WOOD.

O.B. WILLIAMS COMPANY

ESTABLISHED 1889

1939 FIRST AVE. SO. SEATTLE, WASHINGTON 98134 (206) 623-2494 FAX 623-2602

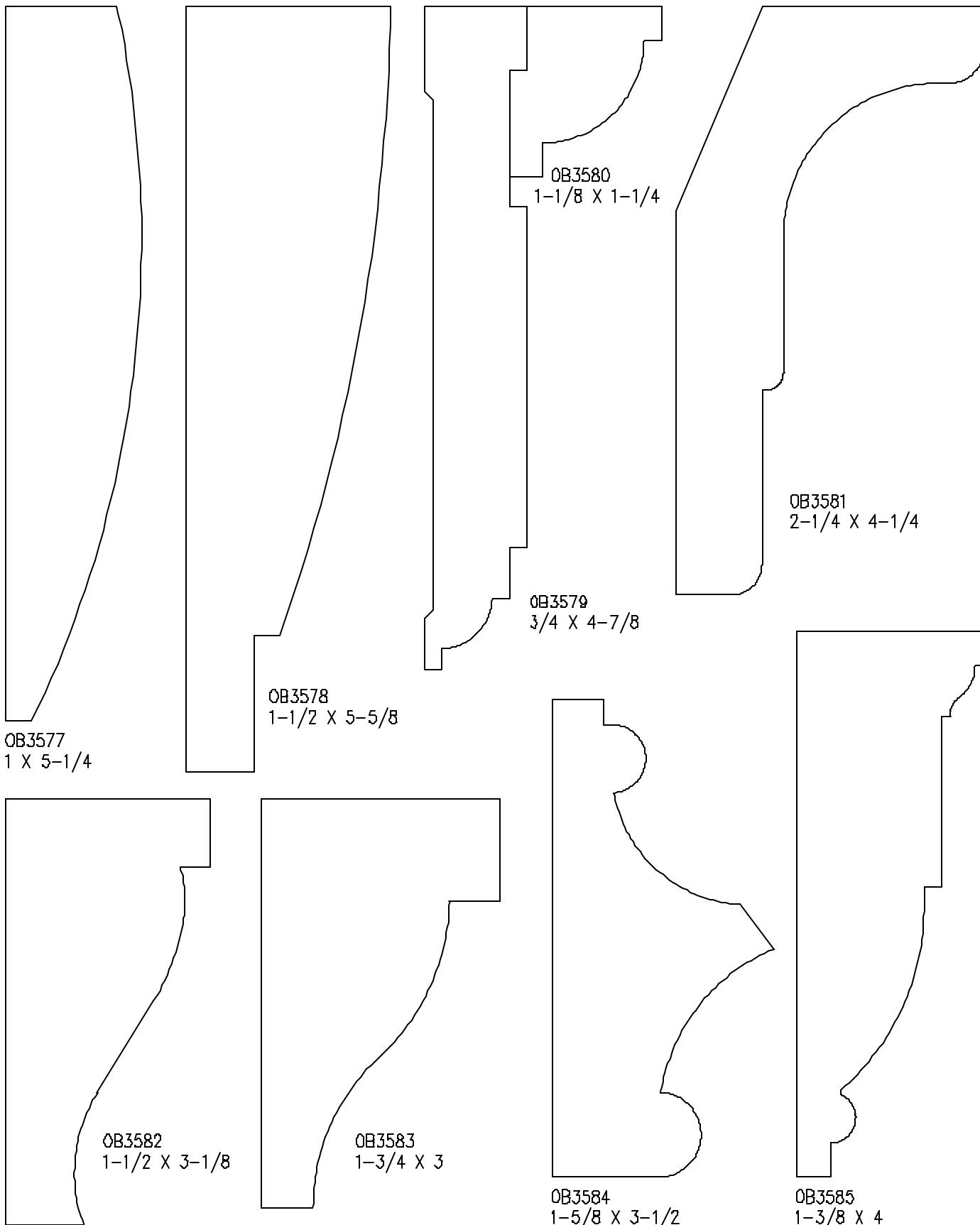

O.B. WILLIAMS COMPANY

ESTABLISHED 1889

1939 FIRST AVE. SO. SEATTLE, WASHINGTON 98134 (206) 623-2494 FAX 623-2602

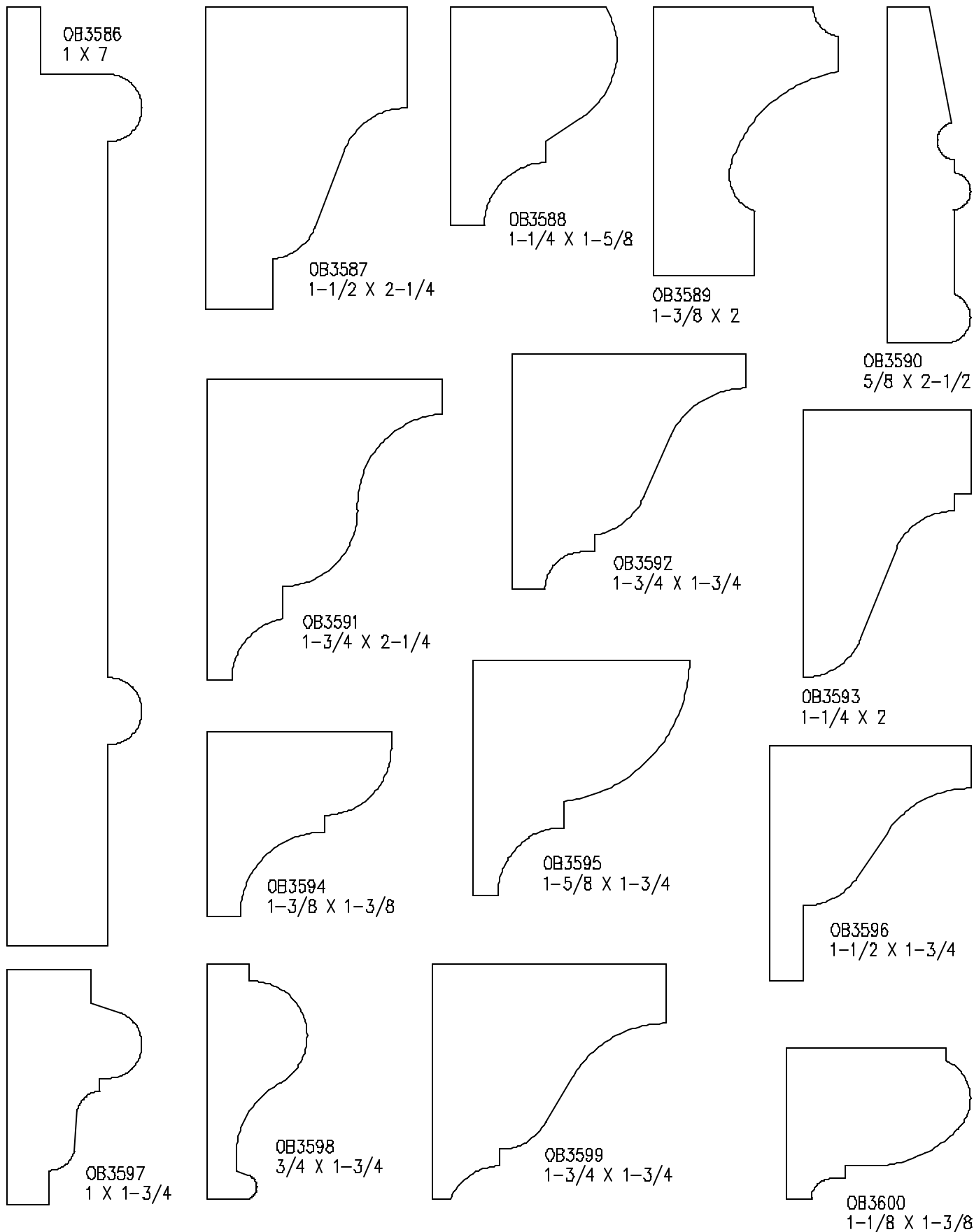

ALL MOULDINGS ARE MADE TO ORDER AND ARE AVAILABLE IN ANY SPECIES OF WOOD.

O.B. WILLIAMS COMPANY

ESTABLISHED 1889

1939 FIRST AVE. SO. SEATTLE, WASHINGTON 98134 (206) 623-2494 FAX 623-2602

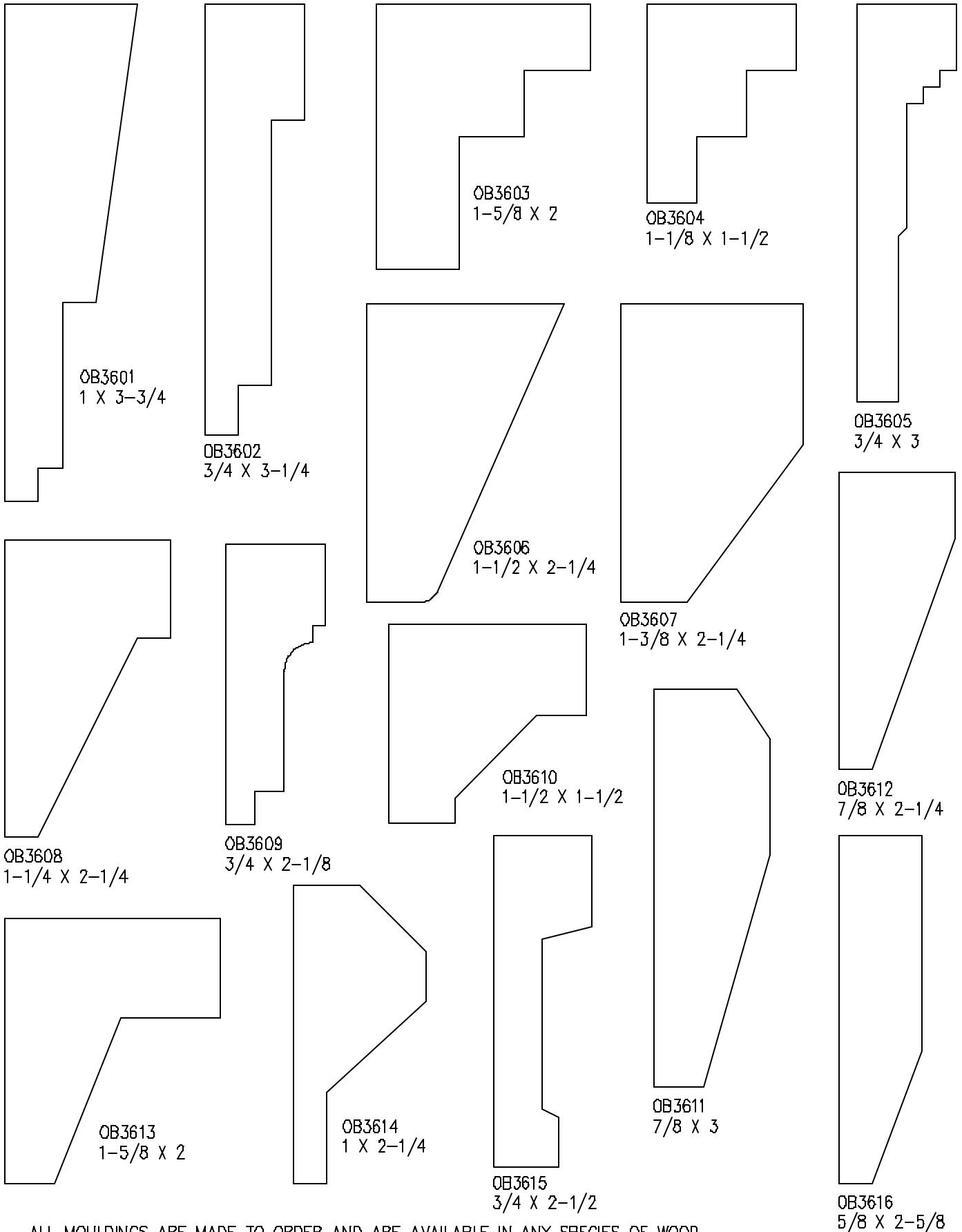



OB3617
3/4 X 2-1/4

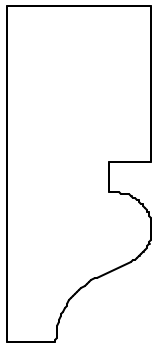

OB3618
3/4 X 1-3/4

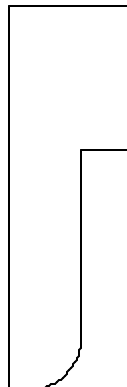

OB3619
5/8 X 2



OB3620
3/4 X 1-3/4

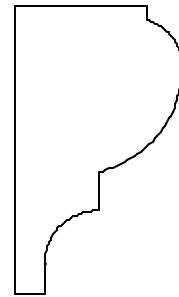

OB3621
7/8 X 1-1/2

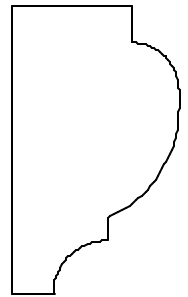

OB3622
7/8 X 1-1/2

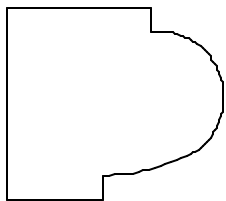

OB3623
1 X 1-1/8

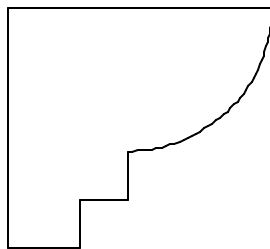

OB3624
1-1/4 X 1-3/8



OB3625
1 X 1-3/8

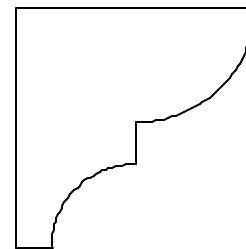

OB3626
1-1/4 X 1-1/4

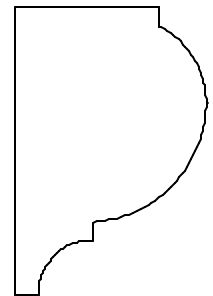

OB3627
1 X 1-1/2

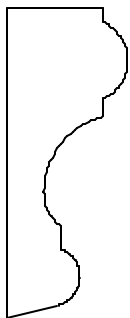

OB3628
5/8 X 1-5/8

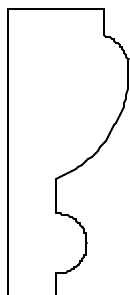

OB3629
5/8 X 1-1/2

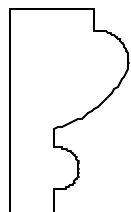

OB3630
5/8 X 1-1/16

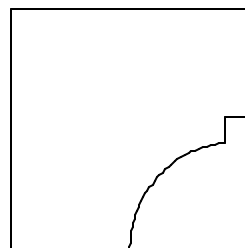

OB3631
1-1/4 X 1-1/4

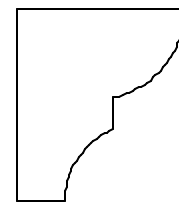

OB3632
7/8 X 1



OB3633
7/16 X 7/8

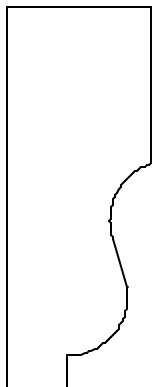

OB3634
3/4 X 2

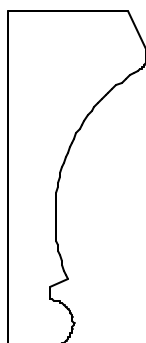

OB3635
3/4 X 1-3/4

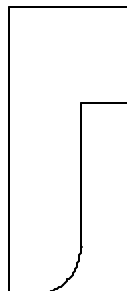

OB3636
5/8 X 1-1/2

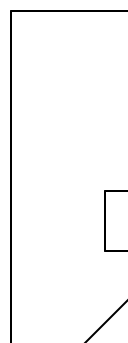

OB3637
5/8 X 1-3/4

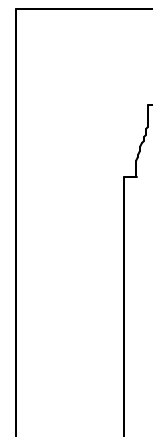

OB3638
3/4 X 2-1/4

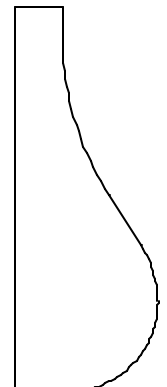

OB3639
3/4 X 2

O.B. WILLIAMS COMPANY

ESTABLISHED 1889

1939 FIRST AVE. SO. SEATTLE, WASHINGTON 98134 (206) 623-2494 FAX 623-2602



OB3701 1-1/4 X 5-3/4



OB3702 1 X 5

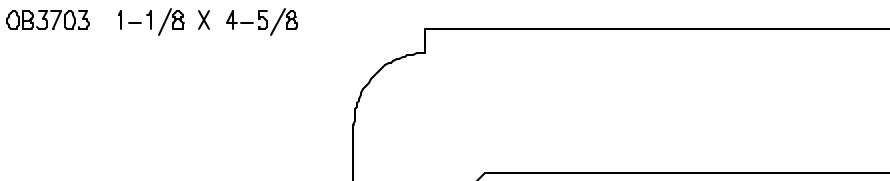

OB3703 1-1/8 X 4-5/8

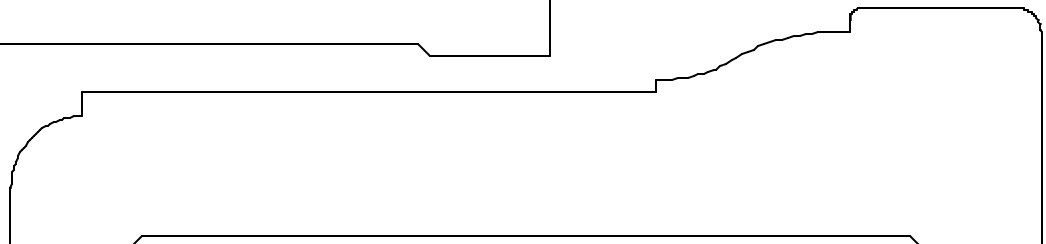

OB3704 1-1/4 X 5-3/8



OB3705 1 X 5

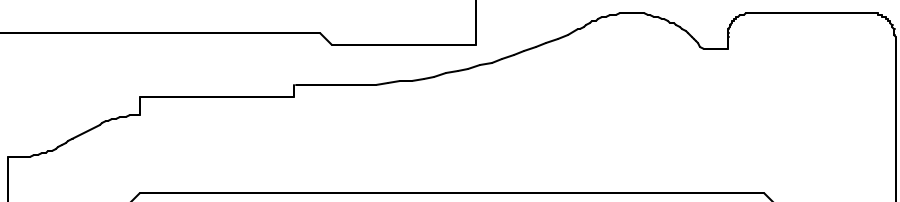

OB3706 1 X 4-5/8



OB3707 1 X 4-1/4

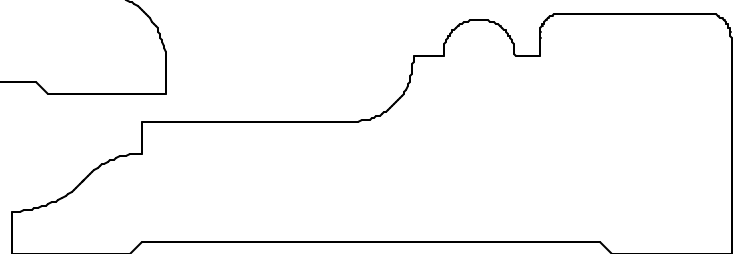

OB3708 1-1/4 X 3-3/4

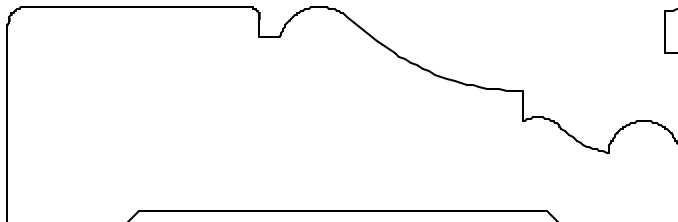

OB3709 1-1/8 X 3-1/2

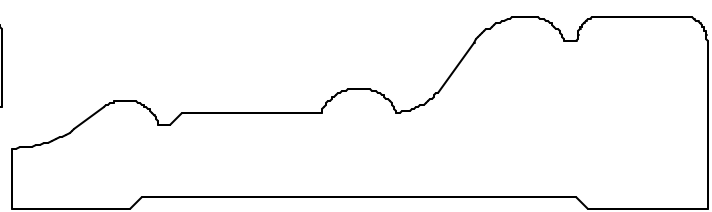

OB3710 1 X 3-5/8

O.B. WILLIAMS COMPANY

ESTABLISHED 1889

1939 FIRST AVE. SO. SEATTLE, WASHINGTON 98134 (206) 623-2494 FAX 623-2602

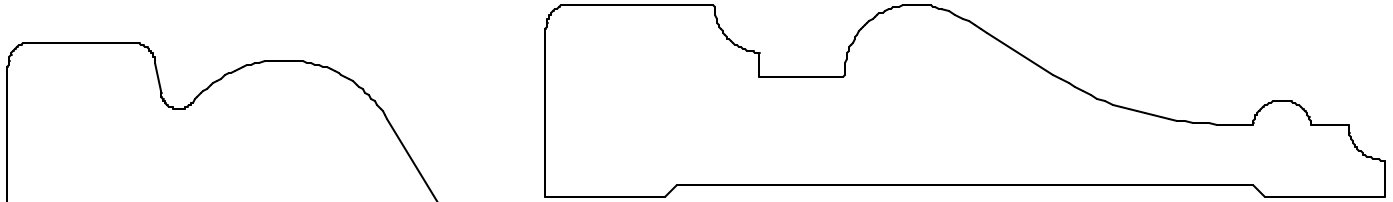

OB3712 1 X 4-3/8

OB3711 2-1/4 X 3-5/8

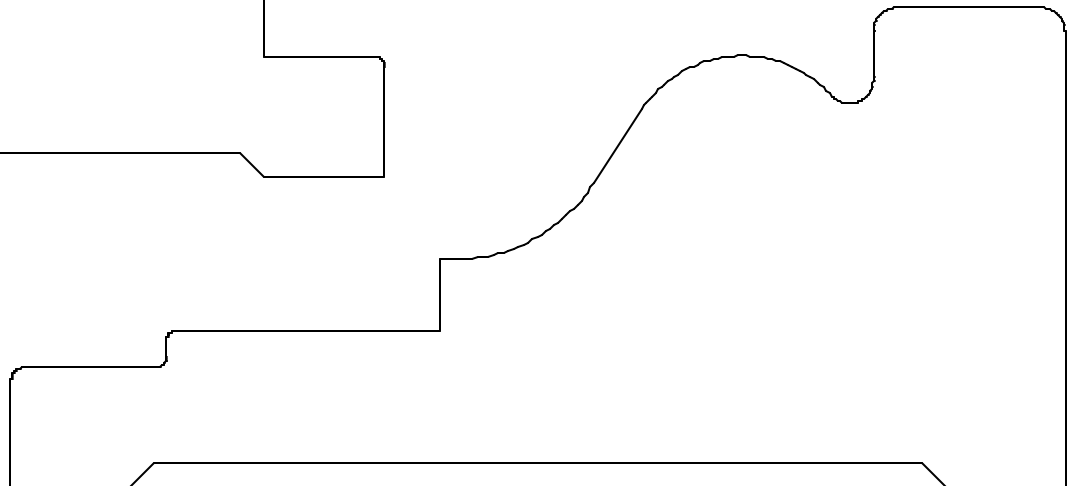

OB3713 2-1/2 X 5-1/2

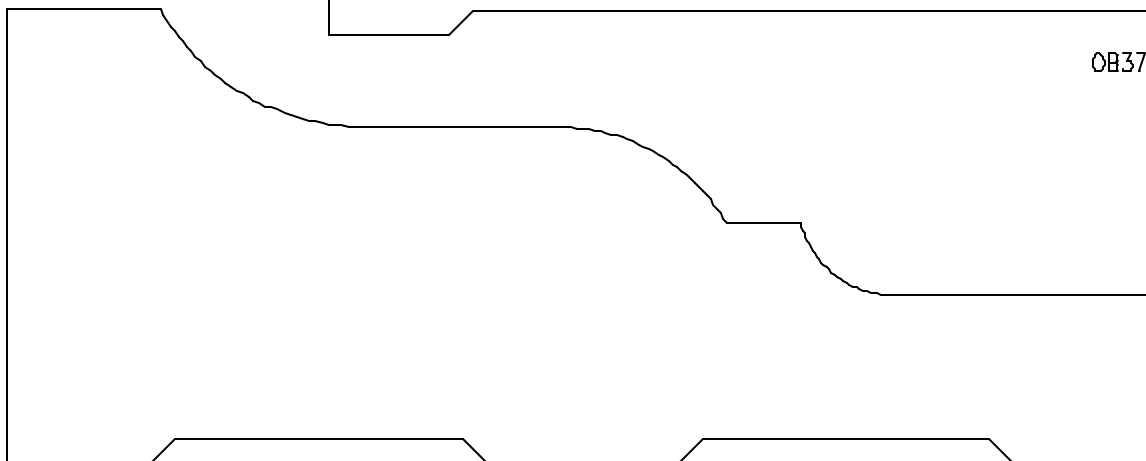

OB3714 2-3/8 X 6

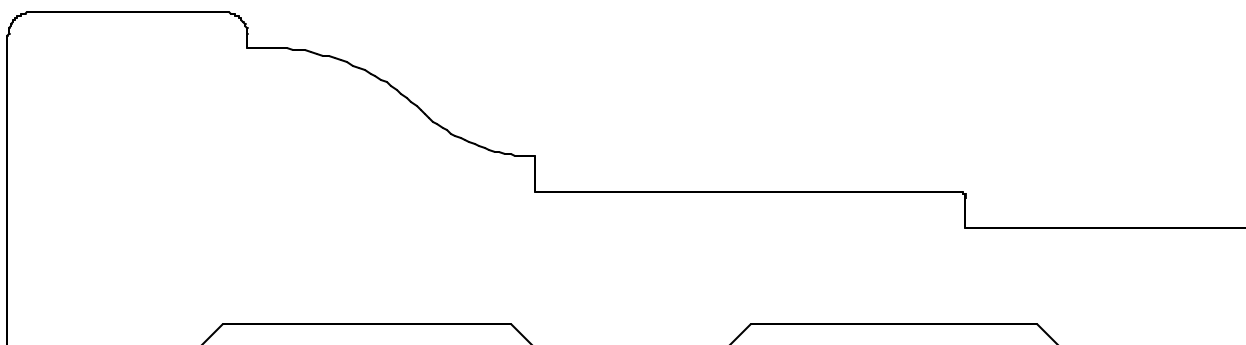

OB3715 1-3/4 X 6-1/2

ALL MOULDINGS ARE MADE TO ORDER AND ARE AVAILABLE IN ANY SPECIES OF WOOD.

O.B. WILLIAMS COMPANY

ESTABLISHED 1889

1939 FIRST AVE. SO. SEATTLE, WASHINGTON 98134 (206) 623-2494 FAX 623-2602

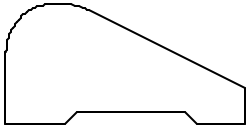

OB3717
5/8 X 1-1/4



OB3718
5/8 X 1-5/8

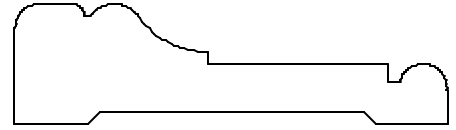

OB3719
5/8 X 2-1/4



OB3720
5/8 X 1-1/2

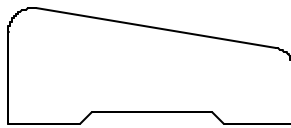

OB3721
5/8 X 1-1/2



OB3722
3/4 X 2-1/2



OB3723
3/4 X 1-3/4

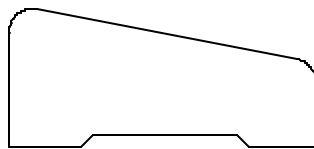

OB3724
3/4 X 1-5/8

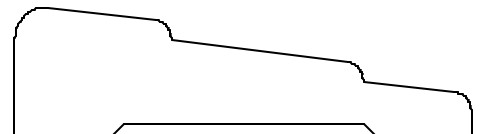

OB3725
11/16 X 2-3/8

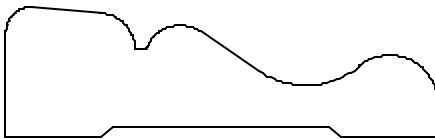

OB3726
11/16 X 2-1/4

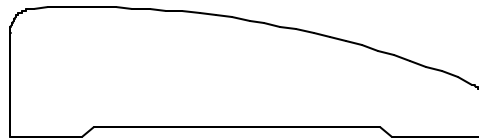

OB3727
11/16 X 2-1/2

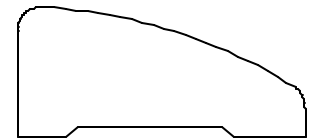

OB3728
11/16 X 1-1/2

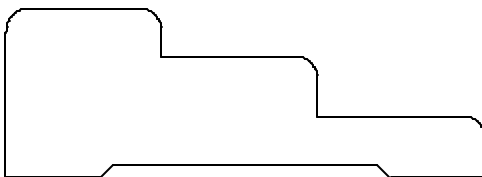

OB3729
7/8 X 2-1/2

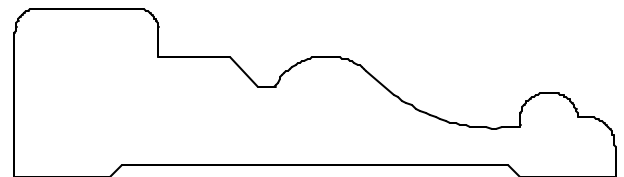

OB3730 7/8 X 3-1/8

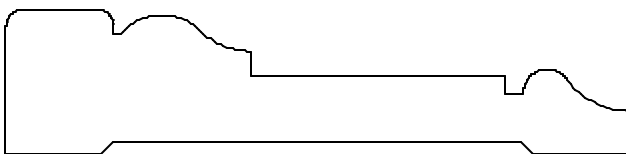

OB3731 3/4 X 3-1/4

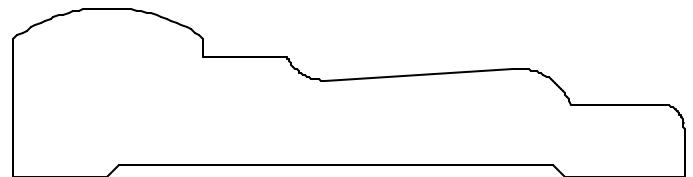

OB3732 7/8 X 3-1/2

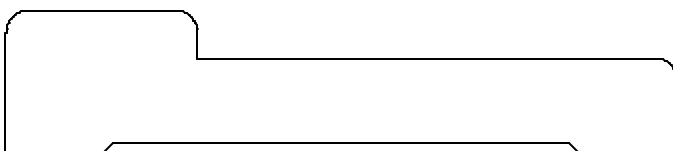

OB3733 3/4 X 3-1/2

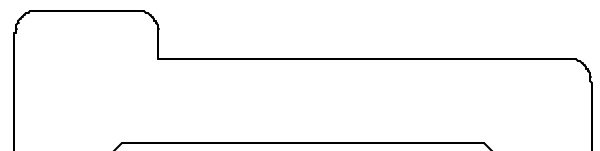

OB3734 3/4 X 3

O.B. WILLIAMS COMPANY

ESTABLISHED 1889

1939 FIRST AVE. SO. SEATTLE, WASHINGTON 98134 (206) 623-2494 FAX 623-2602

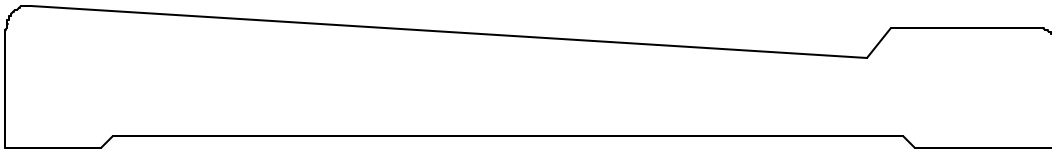

OB3735 3/4 X 5-1/2

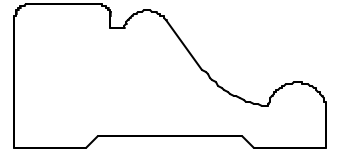

OB3736 3/4 X 1-5/8

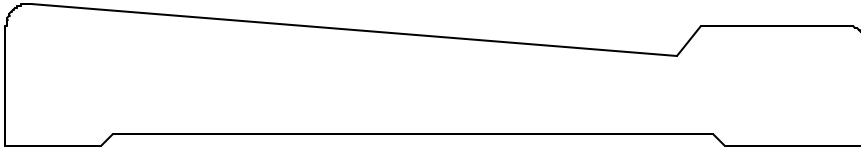

OB3737 3/4 X 4-1/2

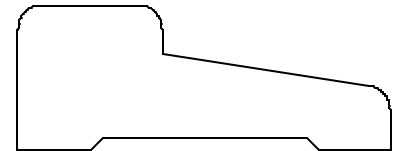

OB3738 3/4 X 1-15/16



OB3739 3/4 X 4-1/4

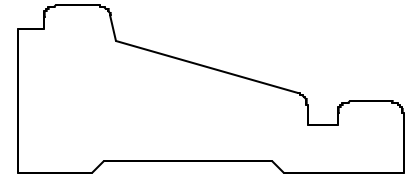

OB3740 7/8 X 2



OB3741 3/4 X 4



OB3742 3/4 X 2

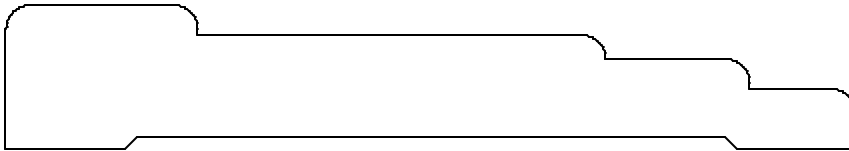

OB3743 3/4 X 4-7/16

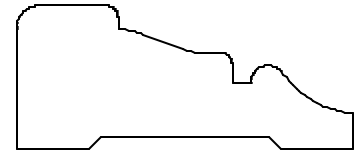

OB3744 3/4 X 1-3/4

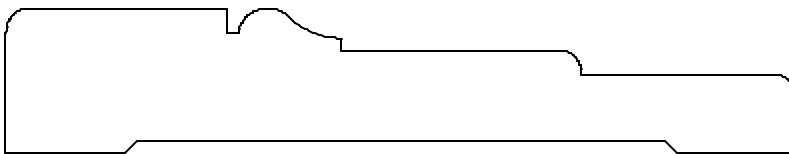

OB3745 3/4 X 4-1/8

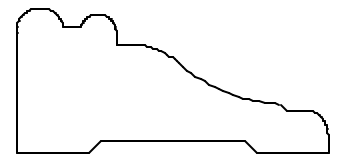

OB3746 3/4 X 1-5/8

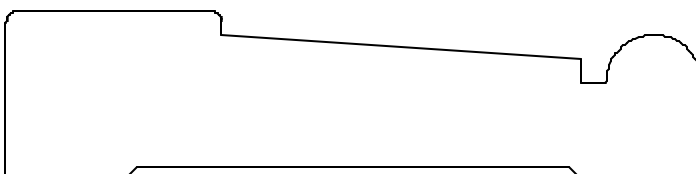

OB3747 7/8 X 3-5/8

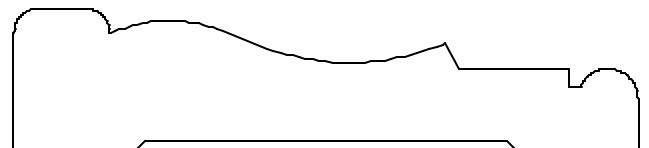

OB3748 3/4 X 3-1/4

ALL MOULDINGS ARE MADE TO ORDER AND ARE AVAILABLE IN ANY SPECIES OF WOOD.

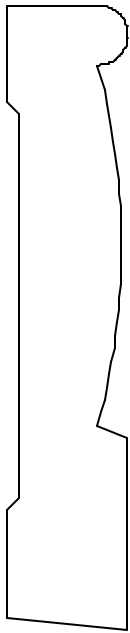

OB3749
5/8 X 3-1/4

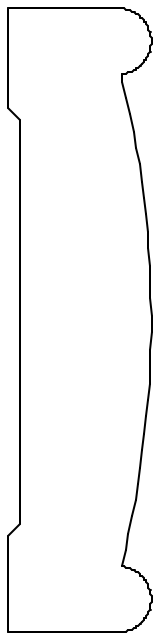

OB3750
3/4 X 3-1/4



OB3751
3/4 X 2-1/4

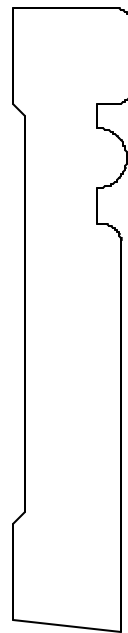

OB3752
5/8 X 3-1/4

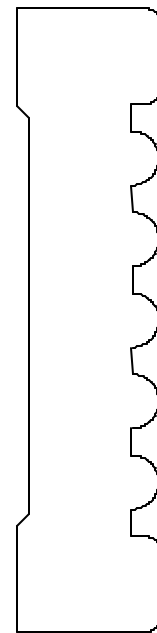

OB3753
3/4 X 3-1/4

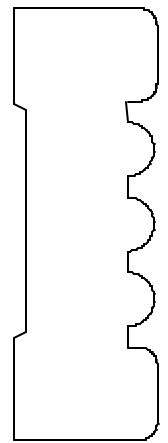

OB3754
3/4 X 2-1/4

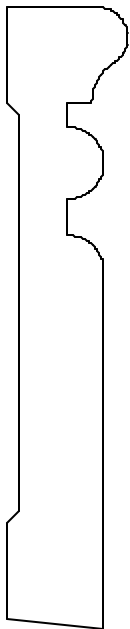

OB3755
5/8 X 3-1/4

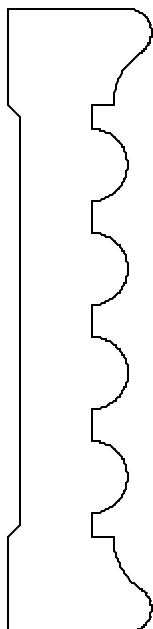

OB3756
3/4 X 3-1/4

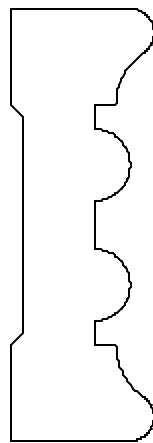

OB3757
3/4 X 2-1/4

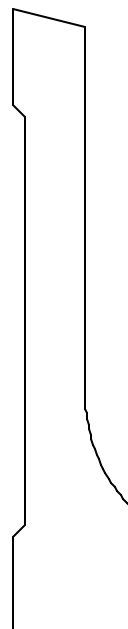

OB3758
5/8 X 3-1/4

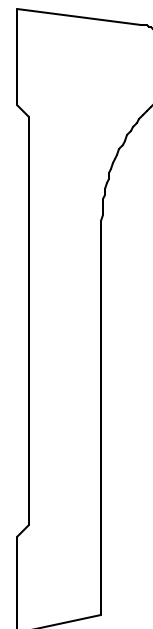

OB3759
3/4 X 3-1/4

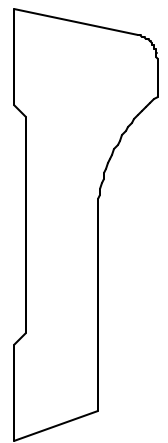

OB3760
3/4 X 2-1/4

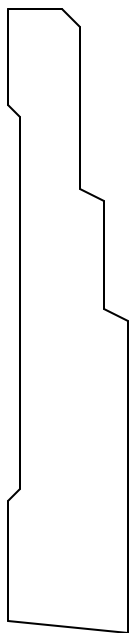

OB3761
5/8 X 3-1/4

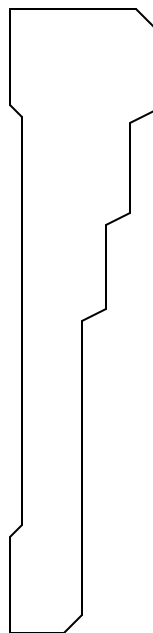

OB3762
3/4 X 3-1/4

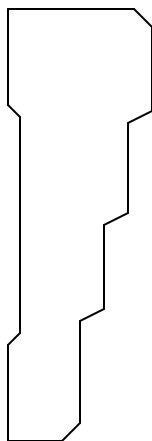

OB3763
3/4 X 2-1/4



OB3764
5/8 X 3-1/4

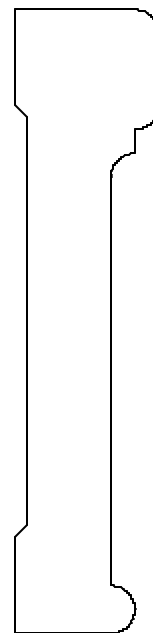

OB3765
3/4 X 3-1/4

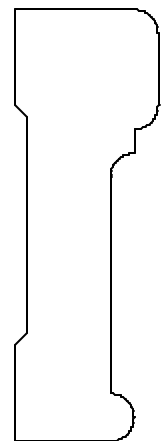

OB3766
3/4 X 2-1/4

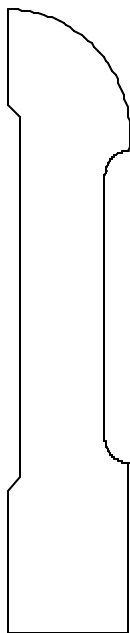

OB3767
5/8 X 3-1/4

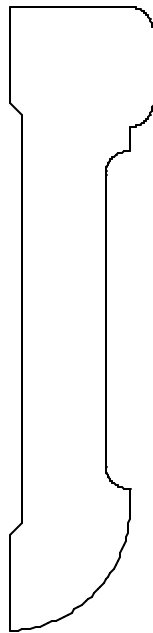

OB3768
3/4 X 3-1/4

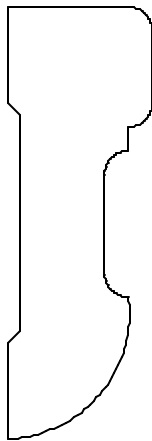

OB3769
3/4 X 2-1/4

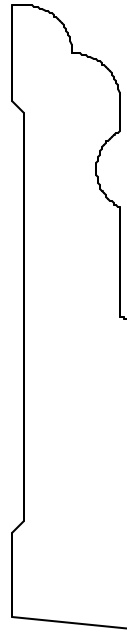

OB3770
5/8 X 3-1/4

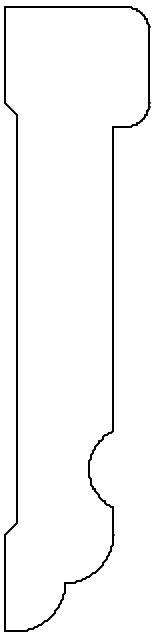

OB3771
3/4 X 3-1/4

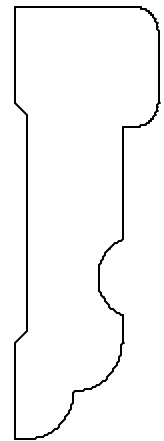

OB3772
3/4 X 2-1/4

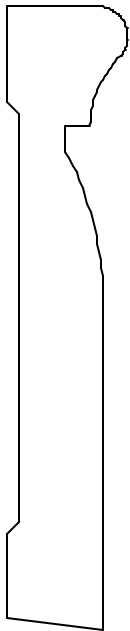

OB3773
5/8 X 3-1/4

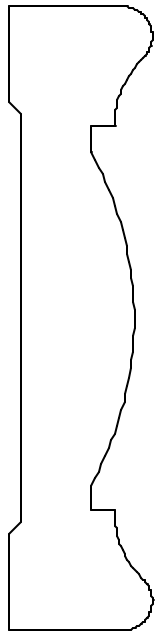

OB3774
3/4 X 3-1/4

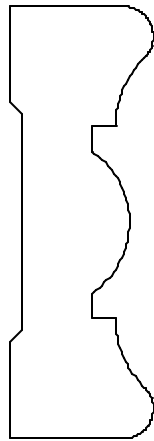

OB3775
3/4 X 2-1/4



OB3776
5/8 X 3-1/4

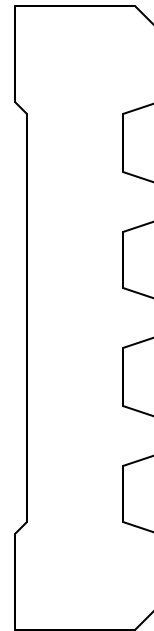

OB3777
3/4 X 3-1/4

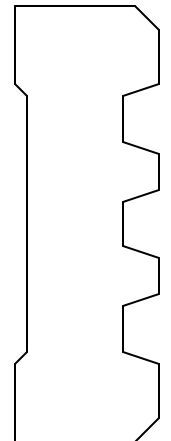

OB3778
3/4 X 2-1/4

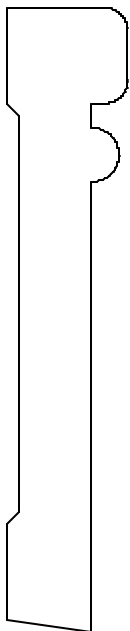

OB3779
5/8 X 3-1/4

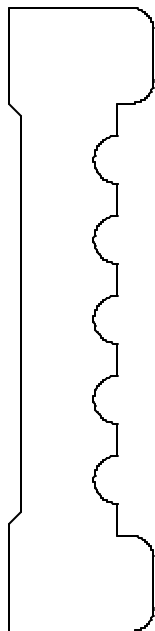

OB3780
3/4 X 3-1/4

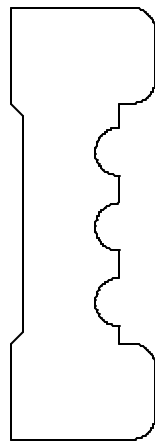

OB3781
3/4 X 2-1/4

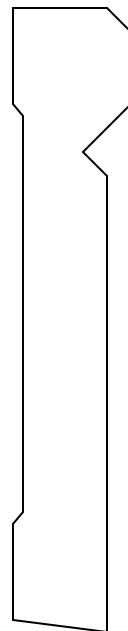

OB3782
5/8 X 3-1/4

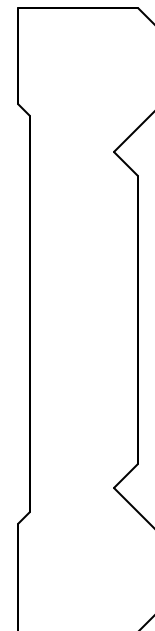

OB3783
3/4 X 3-1/4

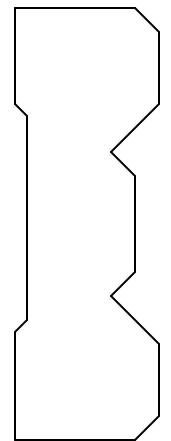

OB3784
3/4 X 2-1/4

ALL MOULDINGS ARE MADE TO ORDER AND ARE AVAILABLE IN ANY SPECIES OF WOOD.

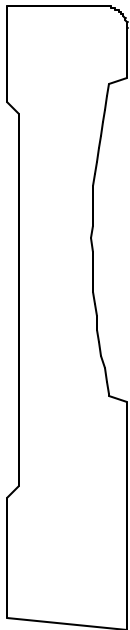

OB3785
5/8 X 3-1/4

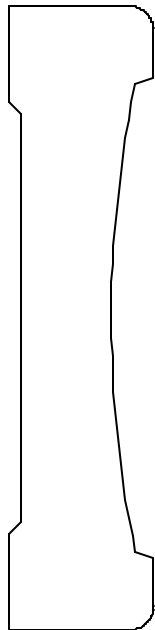

OB3786
3/4 X 3-1/4

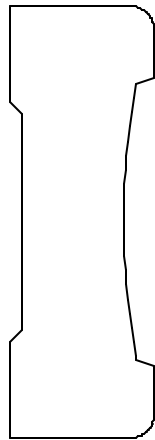

OB3787
3/4 X 2-1/4



OB3788
5/8 X 3-1/4

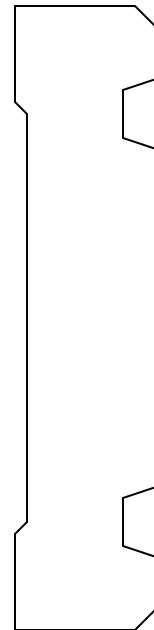

OB3789
3/4 X 3-1/4

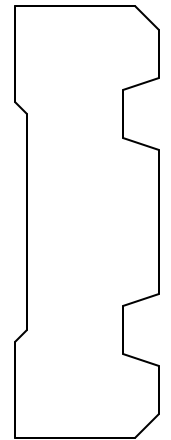

OB3790
3/4 X 2-1/4

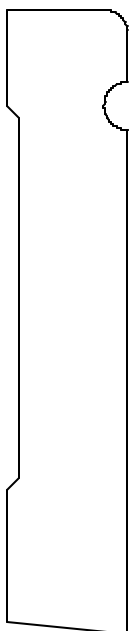

OB3791
5/8 X 3-1/4

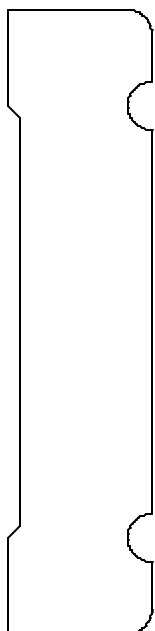

OB3792
3/4 X 3-1/4

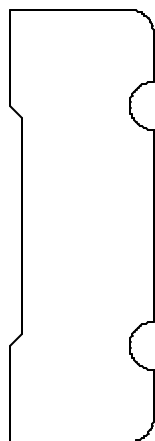

OB3793
3/4 X 2-1/4

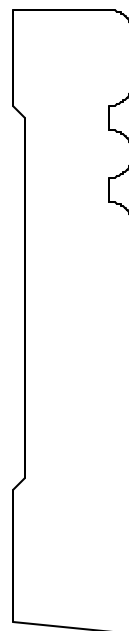

OB3794
5/8 X 3-1/4

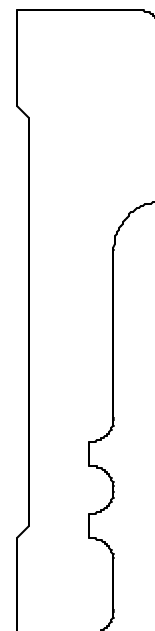

OB3795
3/4 X 3-1/4

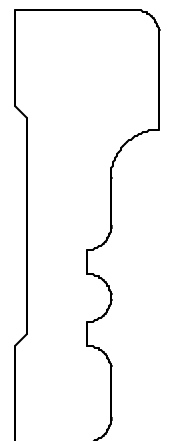

OB3796
3/4 X 2-1/4

O.B. WILLIAMS COMPANY

ESTABLISHED 1889

1939 FIRST AVE. SO. SEATTLE, WASHINGTON 98134 (206) 623-2494 FAX 623-2602

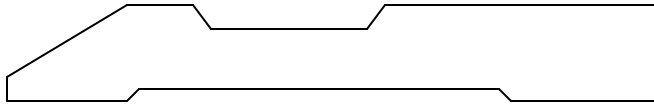

OB3801 1/2 X 3-3/8

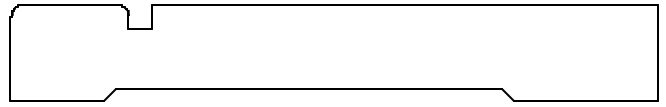

OB3802 1/2 X 3-3/8

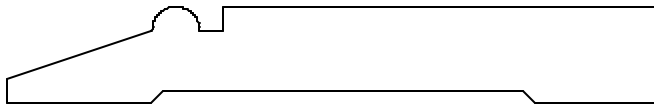

OB3803 1/2 X 3-3/8

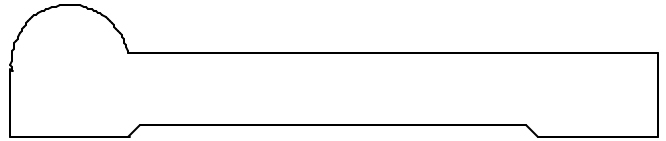

OB3804 11/16 X 3-3/8

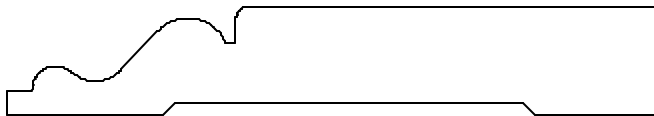

OB3805 9/16 X 3-3/8

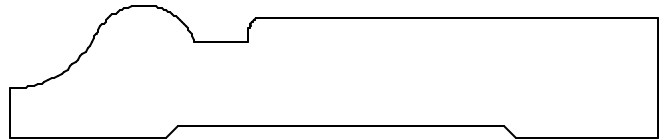

OB3806 5/8 X 3-3/8

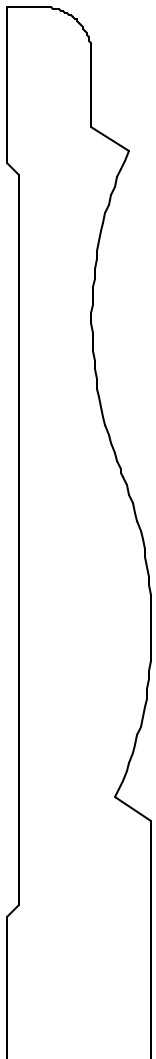

OB3807
3/4 X 5-1/2

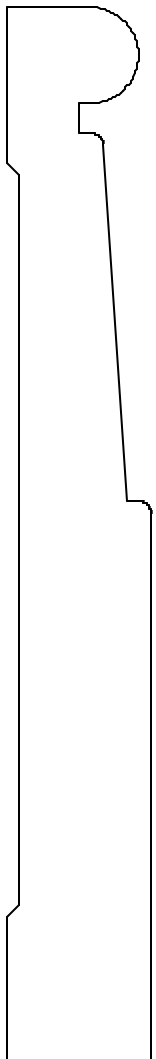

OB3808
3/4 X 5-1/2

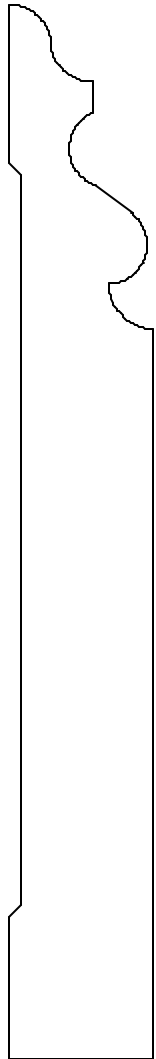

OB3809
3/4 X 5-1/2

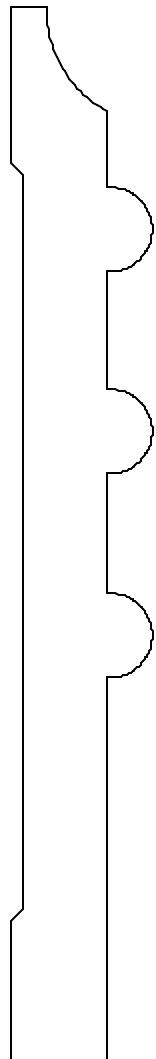

OB3810
3/4 X 5-1/2

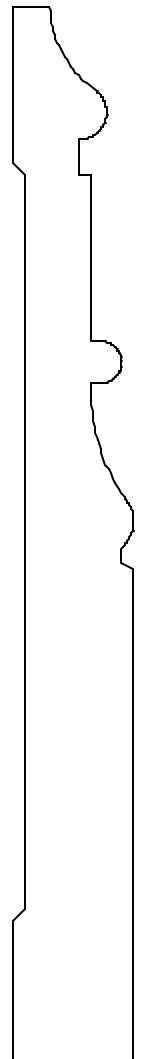

OB3811
5/8 X 5-1/2

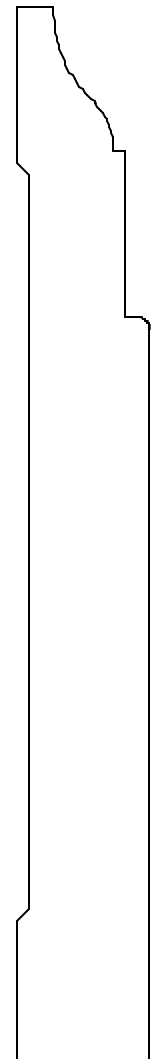

OB3812
11/16 X 5-1/2



OB3813
3/4 X 5-1/2

EDGE SHAPES

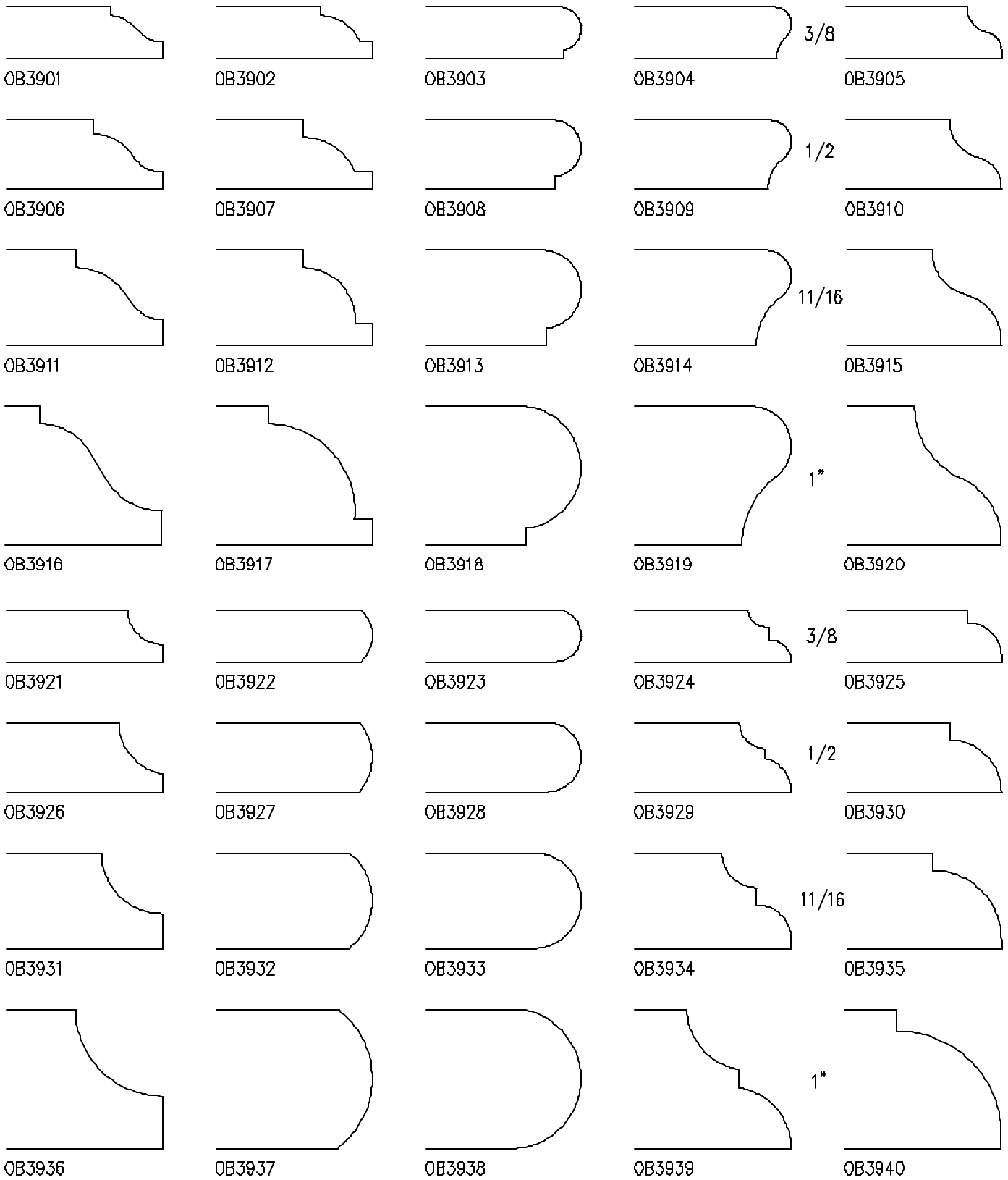

CROWN MOULDING

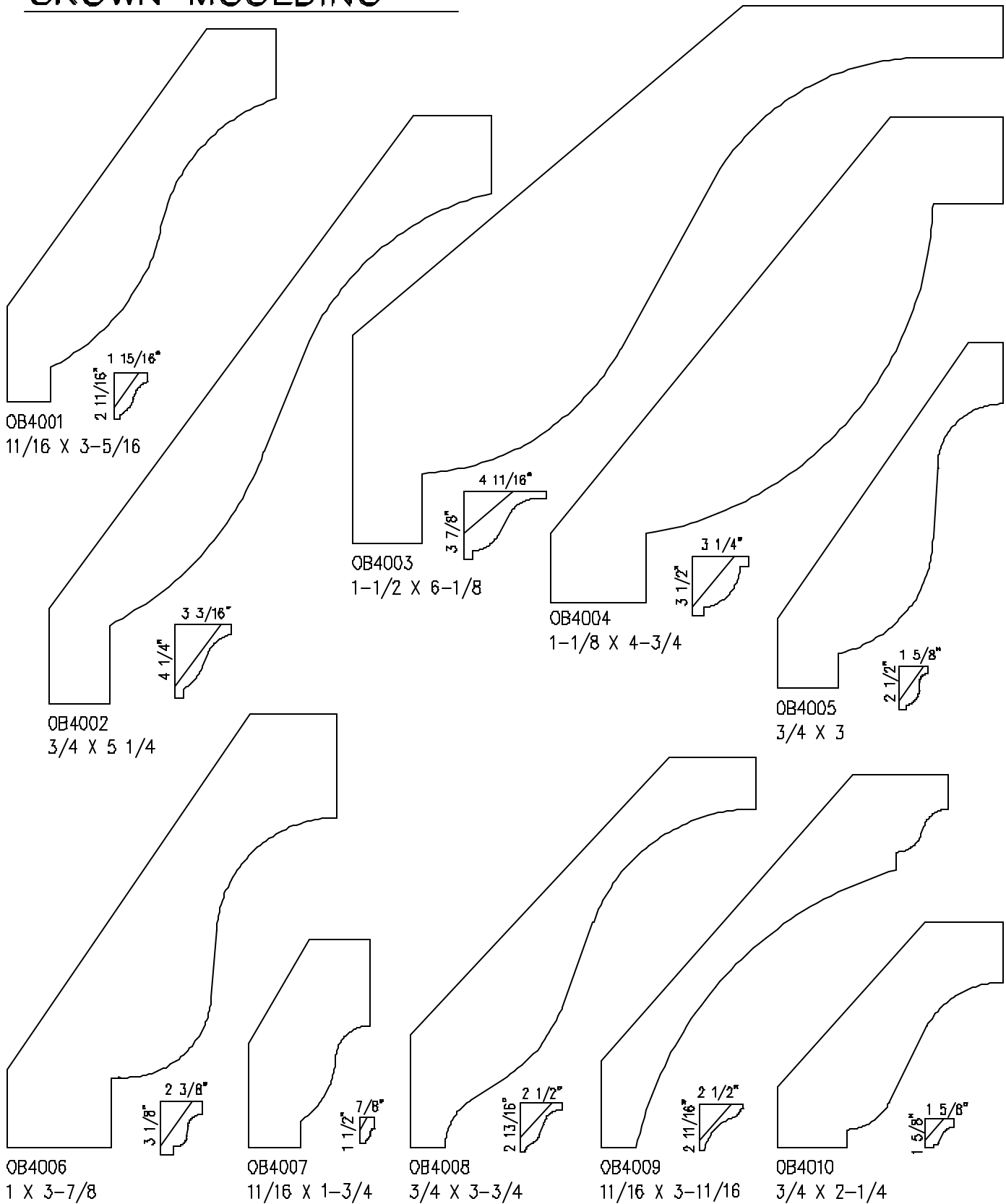

ALL MOULDINGS ARE MADE TO ORDER AND ARE AVAILABLE IN ANY SPECIES OF WOOD.

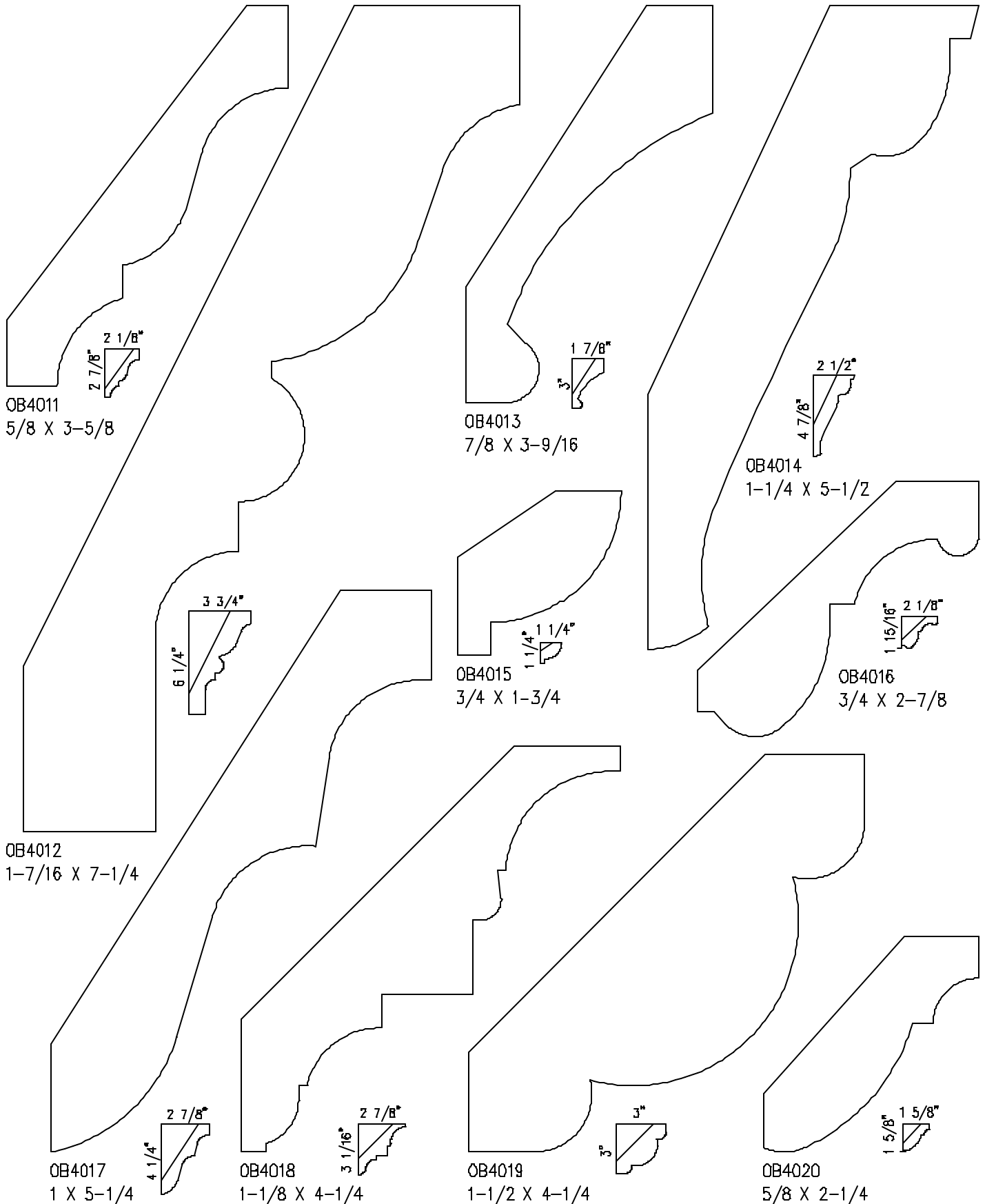

ALL MOULDINGS ARE MADE TO ORDER AND ARE AVAILABLE IN ANY SPECIES OF WOOD.

O.B. WILLIAMS COMPANY

ESTABLISHED 1889

1939 FIRST AVE. SO. SEATTLE, WASHINGTON 98134 (206) 623-2494 FAX 623-2602

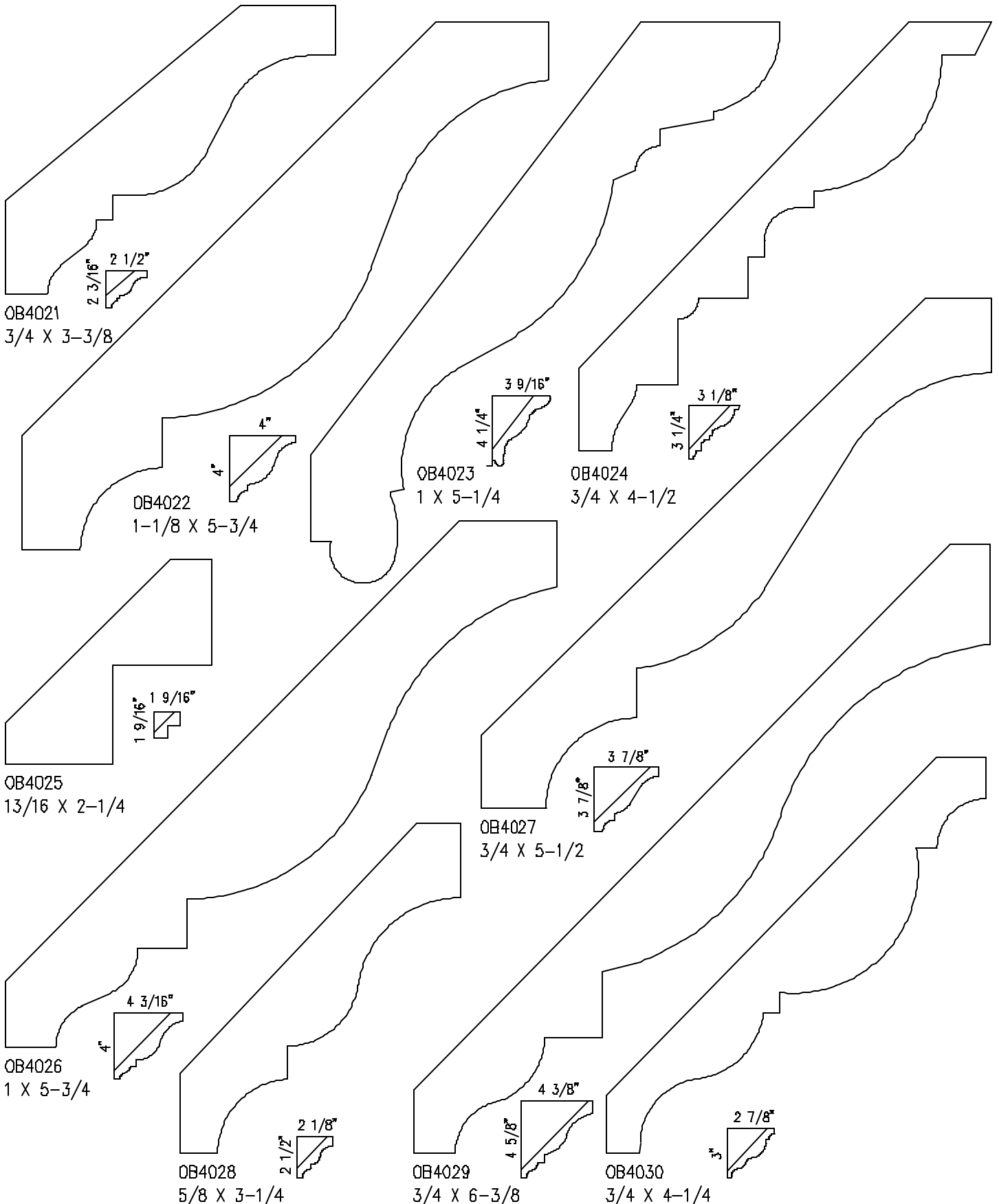

ROSETTES

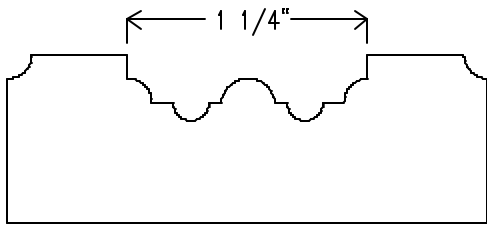

OB5001

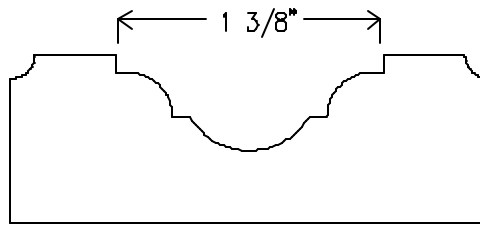

OB5002

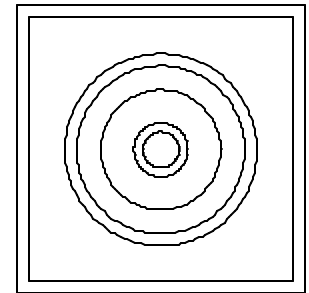

ROSETTES

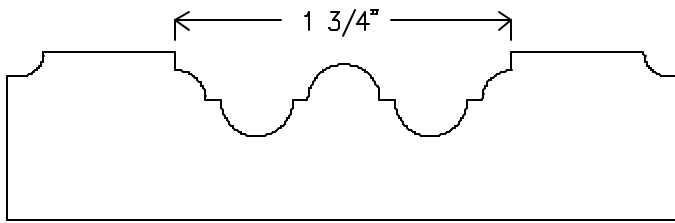

OB5003

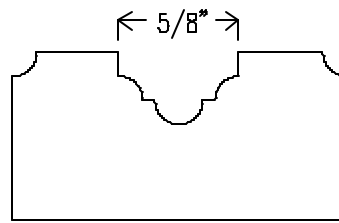

OB5004

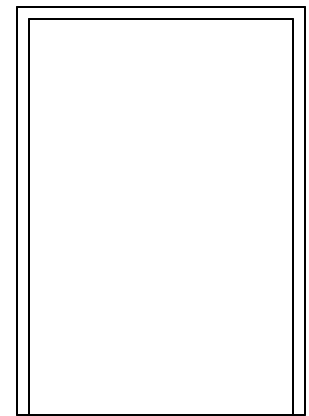

PLINTH BLOCKS

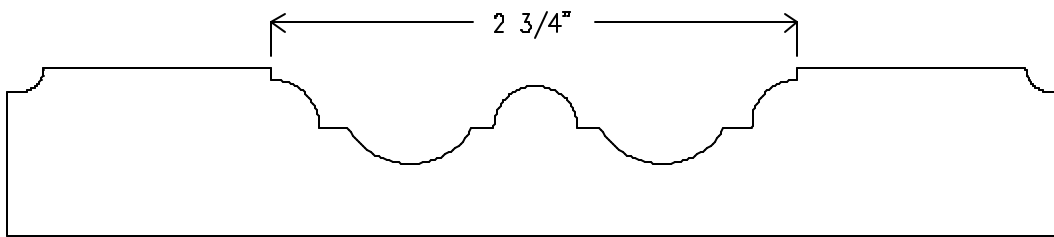

OB5005

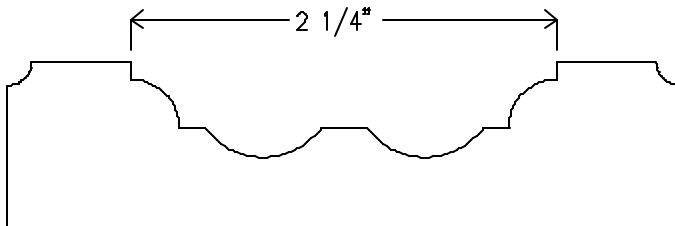

OB5006

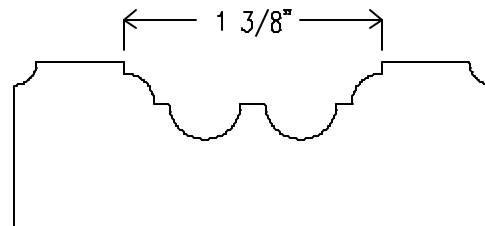

OB5007

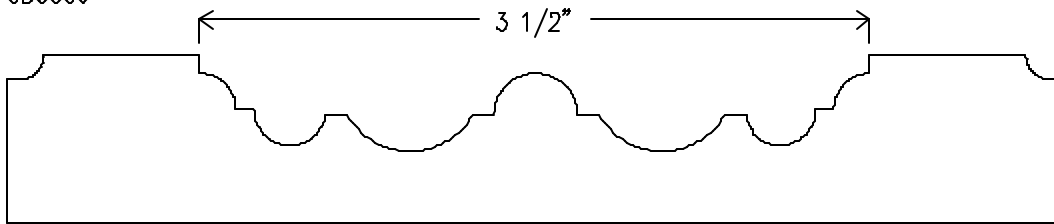

OB5008

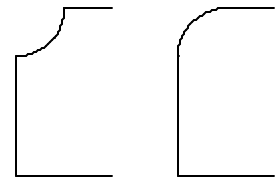

E

F

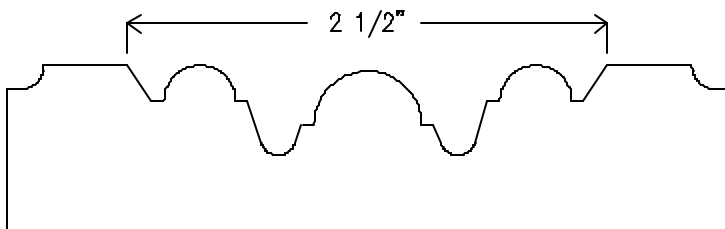

OB5009

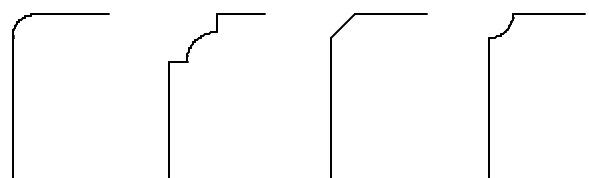

A

B

C

D

OUTSIDE SIZE AND THICKNESS TO ACCOMMODATE CASING SIZE

OPTIONAL OUTSIDE EDGE PROFILES